

Version:  
December 1, 202



# High Voltage Resistor Series

Web: [www.token.com.tw](http://www.token.com.tw)

Email: [rfq@token.com.tw](mailto:rfq@token.com.tw)

## **Token Electronics Industry Co., Ltd.**

**Taiwan:** No.137, Sec. 1, Zhongxing Rd., Wugu District,  
New Taipei City, Taiwan. 248012  
Tel: +886 2981 0109 Fax: +886 2988 7487

**China:** 17P, Nanyuan Maple Leaf Bldg., Nanshan Ave.,  
Nanshan Dist., Shenzhen, Guangdong, China. 518054  
Tel: +86 755 26055363



## Production Index

### High Voltage Resistor Series

Terminology & Glossary.....	1
Terminology & Glossary.....	1
Ceramic Resistors (RMCA, RMCB) .....	4
Product Introduction.....	4
General Specifications .....	5
Electrical Characteristics.....	6
Order Codes .....	6
High Voltage Metal Ceramic Resistor (RMCC) .....	7
Product Introduction.....	7
General Specifications .....	8
Electrical Characteristics.....	9
Order Codes .....	9
High Voltage Ceramic Resistors (RMCD).....	10
Product Introduction.....	10
General Specifications .....	11
Electrical Characteristics.....	11
Order Codes .....	12
High Frequency Resistor (RY31A).....	13
Product Introduction.....	13
Electrical Characteristics.....	14
Order Codes .....	15
High Voltage Hermetic Resistor (RH1) .....	16
Product Introduction.....	16
Dimensions & Specification.....	17
Cleaning & Handling .....	17
Order Codes .....	18
High Voltage Surge Resistor (RI80).....	19
Product Introduction.....	19
General Specifications .....	20
Construction & Dimensions.....	21
Advance Technique .....	22
Order Codes .....	22
High Voltage Resistors (RI82) .....	23
Product Introduction.....	23
Chip General Specifications.....	24
DIP General Specifications .....	25
Advance Technique .....	26
Order Codes .....	26
High Voltage Power Resistors (RI85).....	27
Product Introduction.....	27
Dimensions & Specification.....	28
Derating Curve.....	29



Performance Specifications.....	29
Advance Technique .....	30
Order Codes .....	30
High Voltage Network Dividers (NTK) .....	31
Product Introduction.....	31
NTK-A Electrical Parameters.....	32
NTK-B Electrical Parameters.....	33
Thick Film Planar Dividers, High Voltage Resistors (HI83) .....	34
Product Introduction.....	34
General Specifications .....	35
Electrical Characteristics.....	36
Environmental Characteristics .....	36
Serpentine Pattern .....	37
Application Notes .....	37
Order Codes .....	38
Precision High-Megohm High-Value Chip Resistors (HM) .....	39
Product Introduction.....	39
Dimensions.....	40
HMM Electrical characteristics.....	41
HMS Electrical characteristics .....	43
Order Codes .....	45
Ultra-Precision High-Power High-Voltage Resistors (HI80).....	46
Product Introduction.....	46
HI80D Spec.....	47
HI80DS Spec.....	48
HI80T Spec. ....	49
HI80P Specifications.....	50
Environmental Characteristics .....	51
Power Derating Curve.....	52
Serpentine Pattern .....	53
Order Codes .....	54
Ultra-Precision High Voltage Film Resistors (HI82) .....	56
Product Introduction.....	56
Dimensions.....	57
HI82D Electrical Charcs. ....	59
HI82H Electrical Charcs. ....	60
HI82T Electrical Charcs.....	61
Power Derating Curve.....	62
Advance Technique .....	63
Order Codes .....	64
Carbon Composition Resistors (CCR).....	65
Product Introduction.....	65
Dimensions.....	66
Ratings Specifications .....	66
Derating Curve.....	67
Performance .....	68
Order Codes .....	68



Tubular High Voltage Precision Divider Resistors (HI80M).....	69
Product Introduction.....	69
Dimensions.....	70
Electrical Characteristics.....	71
Derating Curve (HI80M).....	72
Order Codes .....	72
General Information .....	73



## Terminology & Glossary

### Terminology & Glossary

#### Terminology & Glossary

##### Cermet

A cermet resistive element is made from a mixture of glass and metal oxides. The metal oxide is typically  $\text{RuO}_2$  or an AgPt alloy. Applying cermet materials to a flat or cylindrical substrate, and then firing them at  $850^\circ\text{C}$  produce thick Film resistors. In the electronic industry cermet material is typically called Thick Film paste or ink.

##### Critical Resistance Value

The maximum nominal resistance value at which the rated power can be applied continuously without exceeding the maximum working voltage is the critical resistance value. The rated voltage is equal to the maximum working voltage in the critical resistance value. If the circuit designs permits, the choice of a high Ohmic value resistor or divider network will eliminate this consideration.

##### Derating Curve

The curve that describes the relationship between the resistors' operating temperature and the maximum value of continuous power permitted at that temperature. If the circuit designs permits, the choice of a high ohmic value resistor or divider network will minimize this consideration and improve the resistor's performance because it will operate at lower power.

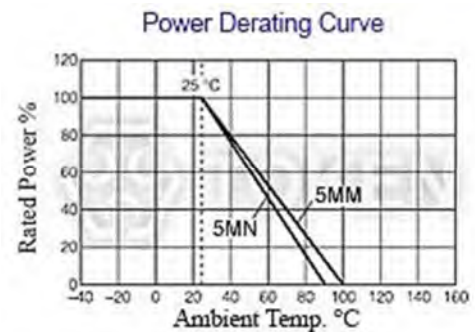

Typical Derating Curve

##### Maximum Working Voltage

The maximum voltage applied continuously to a resistor or a resistor element. The maximum value of the applicable voltage is the rated voltage at the critical resistance value or lower. If the circuit designs permits, the choice of a high ohmic value resistor or divider network will improve the resistor's performance because it will operate at lower power.

##### Noise

Resistive noise can have a devastating effect on low-level signals, charge amplifiers, high gain amplifiers, and other applications sensitive to noise. The best approach is to use resistor types with low or minimal noise in applications that are sensitive to noise. Because of their construction and manufacturing processes.

### Power Rating

Power ratings are based on physical size, allowable change in resistance over life, thermal conductivity of materials, insulating and resistive materials, and ambient operating conditions. For best results, employ the largest physical size resistors at the less than their maximum rated temperature and power. Never use them continuously at their maximum rating unless you are prepared to accept the maximum allowed life cycle changes. If the circuit designs permits, the choice of a high ohmic value resistor or divider network will minimize the power level and improve the resistor's performance as it is operating at a lower power level.

### Rated Power

Rated power is the maximum value of power (watts), which can be continuously applied to a resistor at a rated ambient temperature. The basic mathematical relationship is

**Equation: Power (watts) = (Current (Amps))<sup>2</sup> × Resistance (Ohms).**

If the circuit designs permits, the choice of a high ohmic value resistor or divider network will minimize the power level and improve the resistor's performance because it is operating at a lower power and temperature level.

### Rated Voltage

The maximum voltage applied continuously to a resistor at the rated ambient temperature. Rated voltage is calculated from the following formula, but it must not exceed the maximum working voltage.

**Equation: Rated Voltage (V) = (Rated Power (W) × Nominal Resistance Value (Ω))<sup>1/2</sup>.**

High voltage resistors often are potted or operated in oil as the arc over voltage, in air, is approximately 10,000 volts per inch. Token's resistors feature higher voltage ratings due to their high square count and associated design characteristics.

### Resistor Tolerance

Resistor Tolerance is expressed as the deviation from nominal value in percent and is measured at 25 °C only with no appreciable load applied. A resistors value will also change with applied voltage (VCR) and temperature (TCR). For networks, absolute resistor tolerance refers to the overall tolerance of the network. Ratio tolerance refers to the relationship of each resistor to the others. It is often practical to specify tight ratio tolerances and loose absolute tolerances.





## Temperature Coefficient of Resistance (TCR)

The Temperature Coefficient of Resistance (TCR) is expressed as the change in resistance in ppm (0.0001%) with each degree of change in temperature Celsius (°C). For example, a resistor with a TCR of +100 ppm/°C will change +0.1% total over a 10-degree change and +1% total over a 100-degree change.

The TCR value quoted on specification sheets is typically quoted as being referenced at +25°C and is the +25°C to +75°C slope of the TCR curve. TCR is typically not linear, but parabolic with temperature, as illustrated by the accompanying fig-1. Often the circuit designer treats the TCR as being linear unless very accurate measurements are needed. MIL STD 202 Method 304 is often referenced as a standard for measuring TCR. The following formula expresses the rate of change in resistance value per 1°C in a prescribed temperature range:

- $TCR (ppm/°C) = (R - R_0) / R_0 \times 1 / (T - T_0) \times 10^6$
- R: Measured resistance (Ω) at T °C;      R<sub>0</sub>: Measured resistance (Ω) at T<sub>0</sub> °C
- T: Measured test temperature (°C);      T<sub>0</sub>: Measured test temperature (°C)

In the context of a resistor network, this TCR value is called the absolute TCR in that it defines the TRC of a specific resistor element.

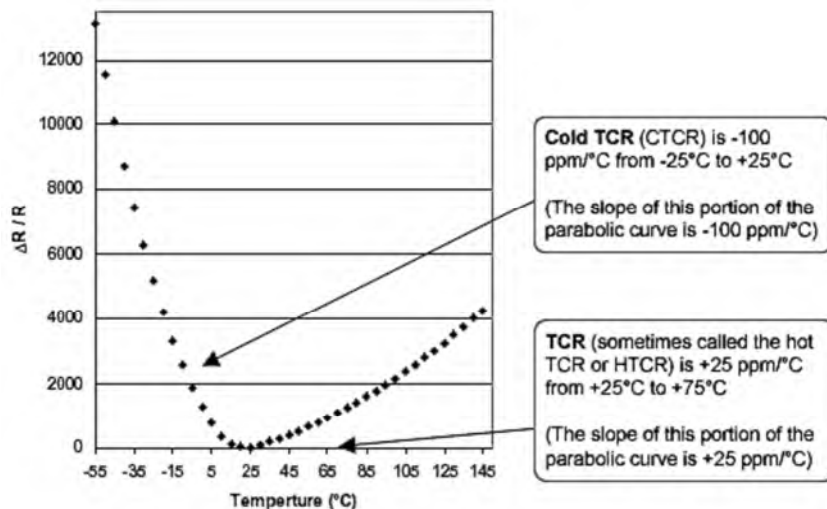

Typical Thick Film TCR (Temperature Coefficient of Resistance) Curve

## Voltage Coefficient of Resistance (VCR)

The Voltage Coefficient is the change in resistance with applied voltage. This is entirely different and in addition to the effects of self-heating when power is applied. A resistor with a VCR of 100 ppm/V will change 0.1% over a 10 Volt change and 1% over a 100 Volt change. The rate of change in resistance value per 1 Volt in the prescribed voltage range is expressed by the following formula:

- $VCR (ppm/V) = (R_0 - R) / R_0 \times 1 / (V_0 - V) \times 10^6$
- R: Measured resistance (Ω) at base voltage; V: Base voltage
- R<sub>0</sub>: Measured resistance (Ω) at upper voltage; V<sub>0</sub>: Upper voltage

# Ceramic Resistors (RMCA, RMCB)

## ► Product Introduction

### Non-Inductive Enhanced Performance for High Voltage Ignition Applications.

#### Features :

- Operating Temperature  $-40^{\circ}\text{C} \sim 155^{\circ}\text{C}$ .
- Resistance Tolerance K( $\pm 10\%$ ), M( $\pm 20\%$ ).
- Typical resistance range 470 ohm  $\sim$  100 Kohm.
- Replaces 1 and 2 watt carbon composition resistors.
- Suitable for noise suppressor of engine ignition system.
- High peak power, Reliable with non-disconnection failure.
- Rated Wattage up 5W, meets high energy density demands.

#### Applications :

- Inrush limiters
- R-C snubber circuits
- Vehicle ignition system
- High voltage power supplies

The RMCA, RMCB Series MELF type of fixed ceramic resistors from Token Electronics offers automotive designers a compact solution for applications involving high voltages, surges, high peak power, or high-energy pulses. They offer enhanced performance in R-C snubber circuits, high voltage power supplies, and inrush limiters.

Token's RMCA, RMCB series now offers the industry a direct replacement carbon composition resistor based on a bulk resistive element comprising carbon in ceramic filler. Due to the need for higher peak voltages, the RMCA, RMCB range is perfect for vehicle ignition system applications.

The RMCA, RMCB Voltage Resistors conform to RoHS compliant and lead free. For customized designs, tighter tolerances, non-standard technical requirements, or custom special applications, please contact us, or link to Token official website "[High Voltage Resistors](http://www.token.com.tw)" to get more information.

#### Ceramic Composition Resistor Construction:

- Bulk ceramic resistor that consists of a clay, alumina, and ceramic filler that has been blended and pressurized into a resistive core and then covered with a molded outer insulating core.

#### Replacement Carbon-Composition Resistors:

- Design requirements for custom sizes, surface mount, or special footprints can be met easily.
- In cases where several carbon-composition resistors have been used together in an array to achieve a particular rating, they have been replaced with a single bulk ceramic resistor, frequently at a lower installed cost.





## General Specifications

### General Specifications (RMCA, RMCB) (Unit: mm)

Model	Style	Rated Wattage	Dimensions (Unit: mm)		
			L	D	
RMC	A	1	7 ± 1.5	4.0 ± 0.4	
			9 ± 1.5	4.0 ± 0.4	
			10 ± 1.5	4.0 ± 0.4	
	B			11 ± 1.5	4.6 ± 0.5
	A	2	18 ± 1.5	4.0 ± 0.4	
			19 ± 1.5	4.6 ± 0.5	
	A	3	24 ± 2.0	4.0 ± 0.4	
			25 ± 2.0	4.6 ± 0.5	
	A	5	24 ± 2.0	7.0 ± 0.5	
			25 ± 2.0	7.6 ± 0.5	

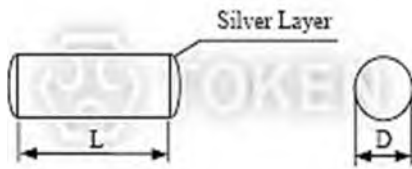

Ceramic Composition Resistor  
(RMC-A) Dimensions

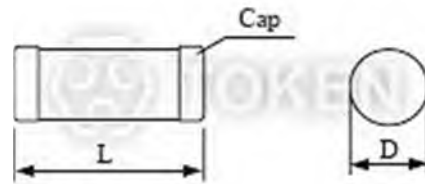

Ceramic Composition Melf  
(RMC-B) Dimensions

## ► Electrical Characteristics

### Electrical Characteristics (RMCA, RMCB)

Item	RMCA, RMCB				
Power Rating at 25°C (W)	1	2	3	5	
Operating Temp. Range (°C)	-40~155				
Resistance Tolerance	K(±10%), M(±20%)				
Resistance Range (Ω)	470~33K	1K~56K	1K~100K	470~33K	
Max. Working Voltage (V)	300	350	400	500	
T.C.R (PPM/°C)	-40°C~25°C	-750~3300	-750~3300	-750~3300	-750~3300
	25°C~155°C	-750~2600	-750~2600	-750~2600	-750~2600
Max. Pulse Voltage (KV)	8	15	20	25	
Moisture Resistance (%)	10	10	10	10	

#### Non-Inductive Performance:

- Chemically inert and thermally stable, the resistors are inherently non-inductive because of their bulk ceramic construction, which allows energy and power to be uniformly distributed through the entire ceramic resistor body with no film or wire to fail.
- The bulk ceramic material also allows simple efficient resistor designs that enable the designer to minimize the resistor package size while providing the required performance and reliability.

## ► Order Codes

### Order Codes (RMCA, RMCB)

RMC	2W	a	510R		M	
Part Number	Rated Power (W)	Style	Resistance Value (Ω)		Resistance Tolerance (%)	
RMC	1W	a Style	510R	510Ω	K	±10%
	2W	b Style	5K1	5.1KΩ	M	±20%
	3W		51K	51KΩ		
	5W		68K	68KΩ		

# High Voltage Metal Ceramic Resistor (RMCC)

## ► Product Introduction

**Metal Ceramic Resistor is The Way Allows Energy and Power to be Uniformly Distributed.**

### Features :

- Operating Temperature  $-40^{\circ}\text{C} \sim 155^{\circ}\text{C}$ .
- Resistance Tolerance K( $\pm 10\%$ ), M( $\pm 20\%$ ).
- Typical resistance range 470 ohm  $\sim$  100 Kohm.
- Replaces 1 and 2 watt carbon composition resistors.
- Suitable for noise suppressor of engine ignition system.
- High peak power, Reliable with non-disconnection failure.
- Rated Wattage up 5W, meets high energy density demands.

### Applications :

- Radar, Motor Drives, Broadcast Transmitters,
- X-Ray, Lasers, Medical Defibrillators,
- Dynamic Braking, Soft-start/Current-limit,
- Snubber Circuits, Dummy Loads, Energy Research,
- RF Amplifiers, Semiconductor Process, Power Conditioning.

Following market demands, Token Electronics provided an extent of Bulk Ceramic Composition RMCA, RMCB Series to RMCC Series. The cap and lead assemblies are pressed onto the RMCC resistor core, finishing the resistor and providing rugged terminal attachment.

Token Surge Resistors - RMCC Series are primarily designed for high voltage, power charging/discharging circuits, surge energy applications and conform to the RoHS directive and Lead-free. For customized designs, tighter tolerances, non-standard technical requirements, or custom special applications, please contact us, or link to Token official website "[High Voltage Resistors](http://www.token.com.tw)" to get more information.



### Bulk Ceramic Construction:

- Bulk metal ceramic resistors that consists of a clay, alumina, and ceramic filler that has been blended and pressurized into a resistive core and then covered with a molded outer insulating core.

### Replacement Carbon-Composition Resistors:

- Design requirements for custom sizes, surface mount, or special footprints can be met easily.
- In cases where several carbon-composition resistors have been used together in an array to achieve a particular rating, they have been replaced with a single bulk ceramic resistor, frequently at a lower installed cost.



## General Specifications

### General Specifications (RMCC)(Unit: mm)

Model	Style	Rated Wattage	Dimensions (mm)			
			L	D	H	d
RMC	C	1	11±1.5	4.8±0.5	25±2	0.8±0.05
	C	2	19±1.5	4.8±0.5	25±2	0.8±0.05
	C	3	25±2.0	4.8±0.5	25±2	0.8±0.05
	C	5	25±2.0	7.8±0.5	30±3	1.0±0.05

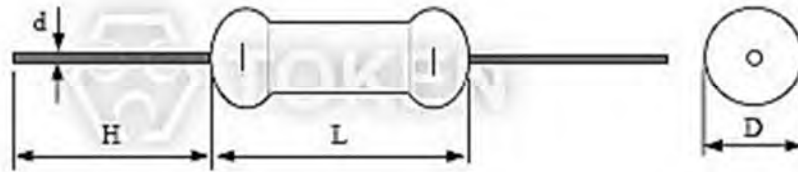

Bulk Ceramic Composition Resistors (RMCC) Dimensions

## Electrical Characteristics

### Electrical Characteristics (RMCA, RMCB)

Item	RMCC				
Power Rating at 25°C (W)	1	2	3	5	
Operating Temp. Range (°C)	-40~155				
Resistance Tolerance	K (±10%), M (±20%)				
Resistance Range (Ω)	470~33K	1K~56K	1K~100K	470~33K	
Max. Working Voltage (V)	300	350	400	500	
T.C.R (PPM/°C)	-40°C ~25°C	-750~3300	-750~3300	-750~3300	-750~3300
	25°C ~155°C	-750~2600	-750~2600	-750~2600	-750~2600
Max. Pulse Voltage (KV)	8	15	20	25	
Moisture Resistance (%)	10	10	10	10	

#### Non-Inductive Performance:

- Chemically inert and thermally stable, the resistors are inherently non-inductive because of their bulk ceramic construction, which allows energy and power to be uniformly distributed through the entire ceramic resistor body with no film or wire to fail.
- The bulk ceramic material also allows simple efficient resistor designs that enable the designer to minimize the resistor package size while providing the required performance and reliability.

## Order Codes

### Order Codes (RMCC)

RMC	2W	c	51K		K	
Part Number	Rated Power (W)	Style	Resistance Value (Ω)		Resistance Tolerance (%)	
RMC	1W	c Style	510R	510Ω	K	±10%
	2W		5K1	5.1KΩ	M	±20%
	3W		51K	51KΩ		
	5W		68K	68KΩ		



# High Voltage Ceramic Resistors (RMCD)

## ► Product Introduction

### Bulk Ceramic Tubular Resistor Offers Higher Energy Power Dissipation & Higher Voltage Withstand.

#### Features :

- Peak voltage up to 74 KV, Power (W) up to 100W.
- Typical resistance range 75 ohm ~ 1 Kohm.
- Resistance tolerance K( $\pm 10\%$ ).
- Inductance only 0.4 $\mu$ H max.
- Heavy load characteristics.

#### Applications :

- X-Ray, Lasers, Medical Defibrillators,
- Dynamic Braking, Soft-start/Current-limit,
- Radar, Motor Drives, Broadcast Transmitters,
- Snubber Circuits, Dummy Loads, Energy Research,
- RF Amplifiers, Semiconductor Process, Power Conditioning.

Power High Voltage Dividers and Resistors Type RMCD extend Token Electronic's advanced proprietary high voltage resistor technology to larger devices than have previously been available on the market.

The RMCD is the bulk non-inductive ceramic tubular resistor. Because of the larger volume of resistive material, these resistors are capable of handling significantly higher pulsed power than their wire wound or metal film counterparts, making them suitable for rapid energy dumping and high energy pulse work.

This RMCD offer higher average power dissipation while retaining the advantages of high surge energy, high voltage withstand, and non-inductance. It is especially useful in RF applications such as transmitters and modulators, where the tube configuration provides more effective convection cooling.

In addition, this RMCD HV resistor and divider provide high peak voltage and power energy combined with extremely high working voltage. These specifications can provide important improvements in performance in many types of advanced electronic systems, including TWT power supplies, radar systems, X-ray systems, analytical equipment and high resolution CRT displays.

Token will also produce devices outside these specifications to meet customer requirements, with comprehensive application engineering and design support available for customers worldwide. For complete information on quantity price and delivery, please contact our Sales Office, or link to Token official website "[High Voltage Resistors](http://www.token.com.tw)" to get more information.



## General Specifications

### General Specifications (RMCD) (Unit: mm)

Type	Dimensions (Unit: mm)			Resistance (Ω)	Tolerance (%)	Energy (KJ)	Peak Voltage (KV)	Power (W)
	L±3.0	ΦD±2.0	Φd±2.0					
RMCD-100	305	25.4	15.5	75~1K	±10	30	75	100
RMCD-90	250	25.4	15.5			25	60	90
RMCD-70	200	25.4	15.5			20	45	70
RMCD-50	150	25.4	15.5			15	30	50
RMCD-35	100	25.4	15.5			10	15	35

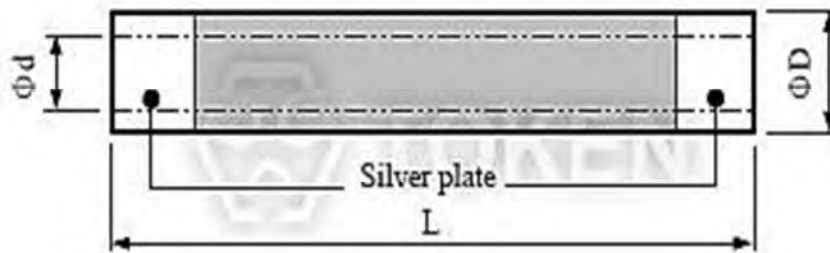

Tubular High Voltage Resistors (RMCD) Dimensions

## Electrical Characteristics

### Electrical Characteristics (RMCD)

Type	Power Rating	Temperature Coefficient	Resistivity	Specific Heat	Inductance	Density	Max. Operating Temperature
RMCD	35 ~ 100W	-500 ~-1500PPM/°C	5~80Ω·cm	2J/cm <sup>3</sup> ·°C	0.4μH max	2.25g/cm <sup>3</sup>	220°C max

## Order Codes

### Order Codes (RMCD)

RMCD	100W	100R		K		S	B	
Part Number	Rated Power (W)	Resistance Value ( $\Omega$ )		Resistance Tolerance (%)		Silver plate terminal	Color	
RMCD	35W	82R	82 $\Omega$	K	$\pm 10\%$		B	black
	50W	100R	100 $\Omega$					
	70W	470R	470 $\Omega$					
	90W	820R	820 $\Omega$					
	100W	1K	1K $\Omega$					

# High Frequency Resistor (RY31A)

## ▶ Product Introduction

### ||| A Perfect Choice for High Frequency RF Circuit Designs

#### Features :

- Special Oxide Film technology
- Speciality product for RF applications
- Low-inductance non-helical trimmed product
- Lead (Pb)-free and RoHS compliant

#### Applications :

- Telecommunication equipment
- Industrial electronics

RY31A specialty MELF Non-Inductive Resistors combines the advanced pulse load capability and the suitability for RF applications in a single component.

They are the perfect choice in RF high frequency circuit designs where the parasitic inductance of regular, helical trimmed resistors cannot be accepted, but where also pulse energies apply. Typical applications are in the fields of telecommunication equipment and industrial electronics.

RY31A - High Frequency Metal Oxide Film Resistor, with the inner and outer surfaces coated with a special glass, features higher thermal resistance and larger electric power capacity for the compact volume. Unlike conventional wire wound type, the volumetric resistance will provide superior stability versus frequency and excellent durability against transient voltage. RY31A is suitable for the application with large current as well as high frequency circuit.

In very low resistance values, between 1.0 and 100 ohm, these are available in rated wattage 10W, 25W, 50W, 100W, and 150W packages.

The High-Frequency RY31A Series is RoHS compliant and lead free. For custom designs, tighter tolerances, non-standard technical requirements, or custom special applications, please contact our Sales Office, or link to Token official website "[High Voltage Resistors](http://www.token.com.tw)" to get more information.



## Electrical Characteristics

### Electrical Characteristics (RY31A)

Rated power (W)	T.C.R (PPM/°C)	Resistance range (Ω)	Tolerance (%)	Pulse test voltage (KV)	Ambient Temp.(70°C Full Power)	D max. (mm)	L max. (mm)	d max. (mm)	l max. (mm)
10	(+20°C ~+125°C) ±400	50	±5(J) ±10(K)	3.2	-55°C ~ +125°C	Φ 15.1	77	Φ 10.7	5±0.5
		75		4					
25		50		5		Φ 25.1	121	Φ 17.9	10±1
		70		6.5					
50		50		7.5		Φ 35.1	202	Φ 23.1	12±1
		75		8.7					
100		50		11		Φ 35.1	302	Φ 23.1	20±2
		75		12.5					
150		50		12.5		Φ 35.1	302	Φ 23.1	20-1
		75		12.5					

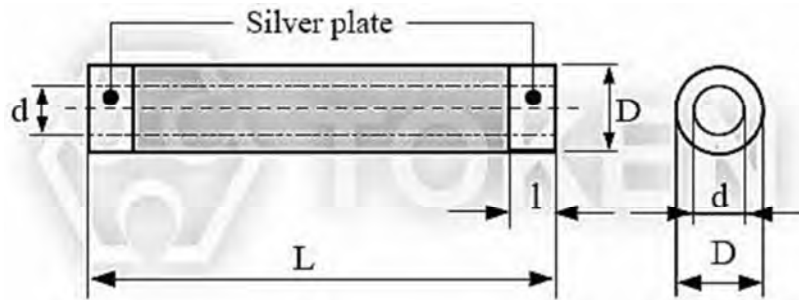

RF Non-Inductive (RY31A) Dimensions

- Note: Request resistance within 1~100Ω, please contact Token Sales.
- The resistors with the standard resistance values as showed as above. will be supplied with a shorter delivery.



## Order Codes

### Order Codes (RY31A)

RY31A	10W	50R		K	
Part Number	Rated Power (W)	Resistance Value ( $\Omega$ )		Resistance Tolerance (%)	
RY31A	10W	51R	51 $\Omega$	J	$\pm 5\%$
	25W	56R	56 $\Omega$	K	$\pm 10\%$
	50W	62R	62 $\Omega$		
	100W	68R	68 $\Omega$		
	150W	75R	75 $\Omega$		

# High Voltage Hermetic Resistor (RH1)

## ▶ Product Introduction

### ||| Hermetic Resistors Lead to a High Ohmic Resistance Values.

#### Features :

- High Resistance Range  $1 \times 10^7 \sim 1 \times 10^{12} (\Omega)$ .
- Resistance Tolerance (J $\pm$ 5%) (K $\pm$ 10%).
- Glass vacuum sealed hermetic resistors.
- Stability temperature and voltage.
- Metal Glaze resistive elements.

#### Applications :

- Ultra-High Vacuum Applications.
- Surge Protection and Voltage Divider.
- Mains Protection and Discharge Path Resistor.
- Current Pulse Limiters and Pulse Load Equipments.
- Micro Current Circuit Measurement, Medical Instrumentation.

Token Hi-Meg Hermetically Sealed Resistors are designed for use in electrometer circuits where a high order of performance is required an extended period of time under adverse environmental conditions.

The RH1 metal glaze resistor is disclosed as being encapsulated in a glass tube, the enclosure being hermetically sealed to conductive caps mounted on the resistor ends. The metal glaze film of the resistance path of the resistor is protected from thermal damage during heat sealing by spacing the resistance path from the conductive caps and providing an electrical path there between in the form of an extended termination.

By being vacuum sealed in a glass envelope with its resistance glaze glass characteristic, these high resistance resistors are suitable for ultra-high vacuum applications, micro current circuit measurement, and pulse load equipment.

These RH1 Series features a high degree of stability and accuracy, and operate at this high performance level for long-term stability.

For customed designs, tighter tolerances, non-standard technical requirements, or custom special applications, please contact us, or link to Token official website "[High Voltage Resistors](http://www.token.com.tw)" to get more information.



## ► Dimensions & Specification

### Dimensions & Specification (RH1) (Unit: mm)

Resistance Range	$1 \times 10^7 \sim 1 \times 10^{12} (\Omega)$
Resistance Tolerance	(J $\pm 5\%$ ) (K $\pm 10\%$ )
Operating Temperature	-55 ~ +125
Temperature Coefficient	$\pm 500 \text{PPM} / (-55 \sim +125^\circ \text{C})$
Damp Heat	$\Delta R \leq \pm (5\%R + 0.1\Omega)$
Working Voltage	1000V
Rated Power	1/2 W

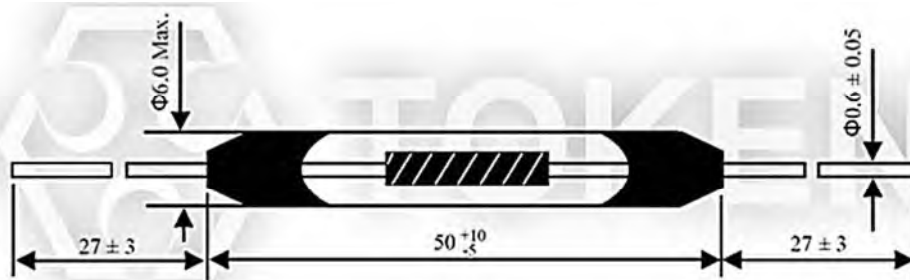

Hermetic High Resistance High-Megohm Resistors (RH1) Dimensions (Unit: mm)

## ► Cleaning & Handling

### Cleaning & Handling (RH1)

#### Hermetic High-Megohm Resistor Cleaning & Handling:

- It should be handled by the leads, unless gloves are worn.
- If cleaning should become necessary, use isopropyl alcohol and lightly wipe dry with lint free tissues.
- These glass encapsulated (hermetic) resistors with high resistance value is required extraordinary cleanliness.
- Fingerprints on the surface of the resistor will attract contaminants and moisture, which will cause a parallel resistance path, reducing the resistance value of the device.

## Order Codes

### Order Codes (RH1)

RH1	1T		J	
Part Number	Resistance Value ( $\Omega$ )		Resistance Tolerance (%)	
RH1	1T	1T $\Omega$	J	$\pm 5\%$
	10T	10T $\Omega$	K	$\pm 10\%$
	100T	100T $\Omega$		

# High Voltage Surge Resistor (RI80)

## ► Product Introduction

### Serpentine Pattern Design Achieves High Power Voltage Resistors (RI80).

#### Features :

- Rated Wattage from 1W to 300W.
- Max Working Voltage from 10KV to 35KV.
- Resistance Tolerance G(  $\pm 2\%$ ), J( $\pm 5\%$ ), K( $\pm 10\%$ ).
- Temperature Coefficient: 200 ppm/ $^{\circ}\text{C}$  to 400 ppm/ $^{\circ}\text{C}$ .
- High Resistance Range from 1 Megohm to 1,000 Megohms.

#### Applications :

- Impulse voltage generators,
- Arc furnace damping, Energy research,
- Pulse modulators, Radar Pulse-forming networks,
- Capacitor crowbar circuits, High voltage snubber circuits,
- X-ray/imaging equipment, and EMI/lightning suppression.

The tubular RI80 high voltage precision resistors were specifically designed for general purpose high voltage systems in industrial. The RI80 uses Token's proprietary thick film Metal Glaze resistive element and Serpentine Pattern Design which provides ideal cost efficient, stability, precision and high voltage characteristics for a wide range of measurement, voltage divider circuits, and control functions in high voltage power electronics applications.

Token RI80 Precision Voltage Resistors are able to absorb large amounts of energy at high voltage while remaining non-inductive and heavy load characteristics. The RI80 conforms to the RoHS directives and Lead-free. Customized design and tighter tolerances are available on request.

By utilizing specific ceramic core materials with optimum processing, Token are able to control, very tightly in manufacturing, the important ultra-stable performance parameters in operating temperatures from  $-55^{\circ}\text{C}$  to  $+70^{\circ}\text{C}$ .

(RI80) can handle up to 35KV voltage. This unique process is offered in specific resistance values in a wide variety of sizes and terminations. The extraordinary operating stability of the Type RI80 resistors will improve the performance of your high voltage system.

The RI80 Precision Voltage Series is for customized designs, tighter tolerances, non-standard technical requirements, or custom special applications, please contact our sales, or link to Token official website "[High Voltage Resistors](http://www.token.com.tw)" to get more information.





## General Specifications

### General Specifications (RI80) (Unit: mm)

Part Number	Rated Wattage (W)	Style	Dimensions (Unit:mm)				Resistance Range ( $\Omega$ )	Temp Coefficient (10-6/ $^{\circ}$ C)	Max Working Voltage (KV)	Operating Temp ( $^{\circ}$ C)	Resistance tolerance (%)
			Lmax	Dmax	I	d					
RI80-1	1	a	30 $\pm$ 2	9 $\pm$ 1	30 $\pm$ 3	0.7 $\pm$ 0.1	1R ~ 1T	1R $\leq$ R<1G, ( $\pm$ 100ppm)	-55 $^{\circ}$ C ~ +70 $^{\circ}$ C	F( $\pm$ 1%) G( $\pm$ 2%) J( $\pm$ 5%) K( $\pm$ 10%)	
RI80-2	2	a	50 $\pm$ 2	9 $\pm$ 1	30 $\pm$ 3	0.7 $\pm$ 0.1					
RI80-3	3	a	65 $\pm$ 2	9 $\pm$ 1	30 $\pm$ 3	0.7 $\pm$ 0.1					
RI80-5	5	a	100 $\pm$ 2	9 $\pm$ 1	30 $\pm$ 3	1 $\pm$ 0.1					
RI80-10	10	a	144 $\pm$ 2	11 $\pm$ 1	30 $\pm$ 3	1 $\pm$ 0.1					
RI80-10	10	b/c	147 $\pm$ 2	11 $\pm$ 1	6 $\pm$ 1	M4					
RI80-20	20	b/c	116 $\pm$ 2	17 $\pm$ 1	10 $\pm$ 1	M6	1R ~ 1G	1G $\leq$ R<10G, ( $\pm$ 200ppm)			
RI80-25	25	b/c	116 $\pm$ 2	19 $\pm$ 1	10 $\pm$ 1	M6					
RI80-30	30	b/c	116 $\pm$ 2	19 $\pm$ 1	10 $\pm$ 1	M6					
RI80-50	50	b/c	116 $\pm$ 2	21 $\pm$ 1	10 $\pm$ 1	M6					
RI80-80	80	b/c	130 $\pm$ 2	27 $\pm$ 1	10 $\pm$ 1	M6					
RI80-100	100	b/c	160 $\pm$ 2	27 $\pm$ 1	10 $\pm$ 1	M6					
RI80-150	150	b/c	210 $\pm$ 2	27 $\pm$ 1	10 $\pm$ 1	M6	1R ~ 200M	100G $\leq$ R $\leq$ 1T, ( $\pm$ 500ppm)			
RI80-200	200	b/c	260 $\pm$ 2	27 $\pm$ 1	10 $\pm$ 1	M6					
RI80-300	300	b/c	310 $\pm$ 2	33 $\pm$ 1	10 $\pm$ 1	M6					

## Construction & Dimensions

### High Voltage Resistors (RI80)



Metal Glaze Serpentine Pattern Impulse Resistors (RI80)

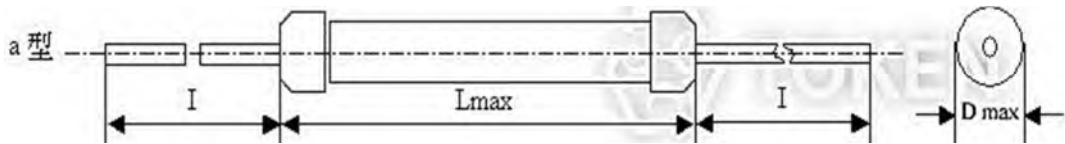

A style Tubular (RI80) - Dimensions (Unit: mm)

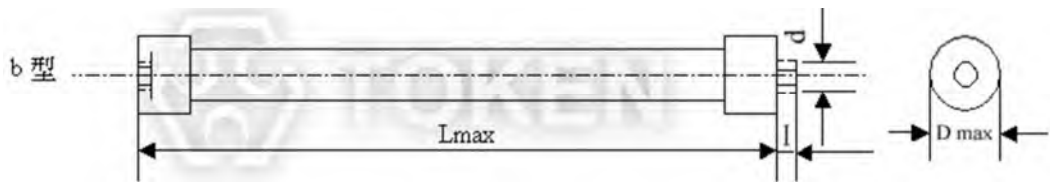

B style Tubular (RI80) - Dimensions (Unit: mm)

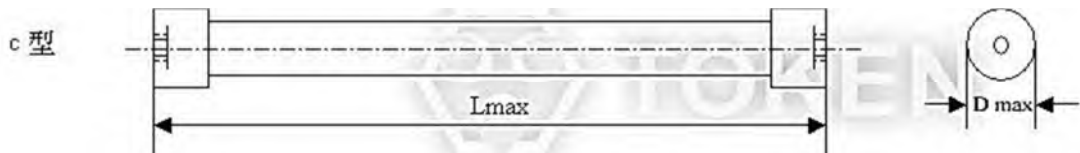

C style Tubular (RI80) - Dimensions (Unit: mm)

**Remark:**

- Rated continuous Working Voltage (RCWV) shall be determined from  $RCWV = \sqrt{\text{Power Rating} \times \text{Resistance Value}} \ (\Omega)$
- When  $RCWV \geq \text{Max. Working Voltage}$  listed above,  $RCWV = \text{Max. Working Voltage}$ .



## ▶ Advance Technique

### Advance Technique of Non-Inductive & Serpentine Pattern (RI80)

#### Non-Inductive Performance:

- RI80 Non-Inductive Design which uses a serpentine resistive pattern that offers for zigzagging lines to carry current in opposite directions, thereby achieving maximum neutralization of flux fields over the entire length of the resistor.
- This efficient non-inductive construction without derating of any performance advantages is ideal for applications where high frequency is required.



#### Serpentine Pattern Screen Printing Design:

- Type High Voltage RI80 Precision Resistors combine Token's Non-Inductive serpentine pattern, high thru-put screen printed silicone coating.
- The alignment of the gap in the serpentine resistor pattern with the gap in the coating pattern provides a complete encapsulation of the resistor element.
- The cap and lead assemblies are pressed onto the resistor core, finishing the resistor and providing rugged terminal attachment.

## ▶ Order Codes

### High Voltage Resistors (RI80)

RI80	1W	a	51M		G	
Part Number	Rated Power (W)	Style	Resistance Value ( $\Omega$ )		Resistance Tolerance (%)	
RI80	1W	a Style	5M1	5.1M $\Omega$		
	2W	b Style	51M	51M $\Omega$	G	$\pm 2\%$
	3W	c Style	510M	510M $\Omega$	J	$\pm 5\%$
	5W				K	$\pm 10\%$
	10W					



# High Voltage Resistors (RI82)

## ► Product Introduction

### An Excellent Solution for The High Voltage Trend in Power Impulse Products.

#### Features :

- Rated Wattage from 0.1W to 30W
- Max Working Voltage from 2KV to 30KV.
- Designs built from customer supplied schematics
- Tough epoxy-based coating and high voltage stability
- Temperature Coefficient: 200 ppm/°C to 300 ppm/°C.
- Resistance Range from 10 Megohm to 100K Megohms (100 Gegaohms).
- Resistance Tolerance F(±1%), G(±2%), J(±5%), K(±10%), and M(±20%).
- Stable cermet resistive element bonded to a high-purity alumina substrate.

#### Applications :

- X-ray/imaging equipment, Impulse voltage generators,
- Capacitor crowbar circuits, High voltage snubber circuits, Arc furnace damping,
- Pulse modulators, Radar Pulse-forming networks, Energy research, and EMI/lightning suppression.
- Applications include power supplies, transformers and any application requiring operation within an environment where high voltages are used.

The High Voltage RI82 Precision Series provides an excellent solution for design engineers looking for a compact product with high-voltage capabilities to enable them to design within the voltage trend for power impulse products.

The RI82 resistors use Token's proprietary thick film Metal Glaze resistive element and Serpentine Pattern Design which provides ideal cost efficient, stability, precision, non-Inductive, and high voltage characteristics for a wide range of measurement, voltage divider circuits, and control functions in high voltage power electronics applications.

By utilizing specific 96 % pure alumina materials with optimum processing, Token are able to control, very tightly in manufacturing, the important ultra-stable performance tolerance F(±1%), G(±2%), J(±5%), K(±10%), and M(±20%). Voltage handles up to 30 KV. This unique process is offered in specific resistance values in a wide variety of sizes and terminations. The extraordinary operating stability of the Type RI82 resistors will improve the performance of your high voltage system in precision.

The Precision RI82 High Voltage Series is RoHS compliant and lead free. For customized designs, tighter tolerances, non-standard technical requirements, or custom special applications, please contact us, or link to Token official website "[High Voltage Resistors](http://www.token.com.tw)" to get more information.



## Chip General Specifications

### Chip Type General Specifications (Unit: mm) (RI82)

Part Number	Rated Wattage (W)	Style	Dimensions (Unit: mm)					Resistance Range ( $\Omega$ )	Temp Coefficient (10-6/ $^{\circ}\text{C}$ )	Resistance Tolerance	Max Working Voltage (KV)
			L Max	S Max	H Max	I	D Max				
RI82-2	2	a	33	8	0.8			10M-1T	$\leq 200$	J( $\pm 5\%$ ) K( $\pm 10\%$ ) M( $\pm 20\%$ )	15
RI82-2	2	a	25	10	0.8						

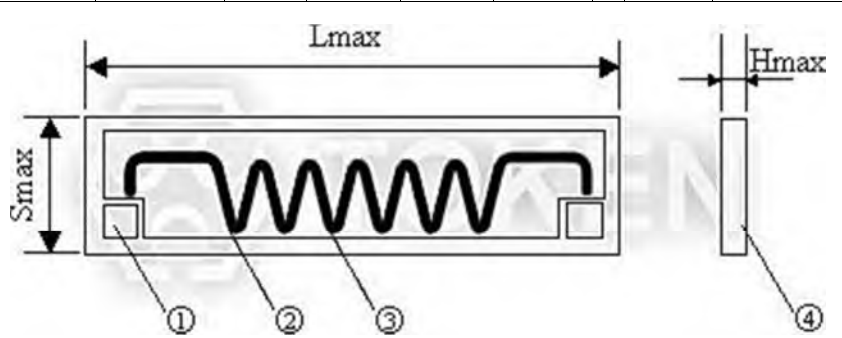

A Style Dimensions - High Voltage Chip Resistor (RI82)

- ① Silver Palladium Pole
- ② Resistent Film
- ③ Insulation Coating
- ④ 96%A1023 Ceramic Base

**Remark:**

- Rated continuous Working Voltage (RCWV) shall be determined from  $RCWV = \sqrt{\text{Power Rating} \times \text{Resistance Value}} (\Omega)$
- When  $RCWV \geq \text{Max. Working Voltage}$  listed above,  $RCWV = \text{Max. Working Voltage}$ .





## DIP General Specifications

### Dip Type General Specification (Unit: mm) (RI82)

Part Number	Rated Wattage (w)	Dimensions (Unit: mm)					Resistance Range (Ω)	Temp Coefficient (10-6/°C)	Max Working Voltage(KV)	Resistance Tolerance
		L±2	S±2	H Max	I	d±0.1				
RI82-0.125	0.125	8	3.5	2.5	20.0Min	0.56	100M-4.7G	1R≤R<1G, (±100PPM)  1G≤R<10G, (±200PPM)  10G≤R<100G, (±300PPM)  100G≤R≤1T, (±500PPM)	4	F(±1%) G(±2%) J(±5%) K(±10%) M(±20%)
RI82-0.125	0.125	10	5	2.5	24.0Min	0.56	100M-10G		4	
RI82-0.25S	0.25S	10	5	2.5	20.0Min	0.56	10M-1T		4	
RI82-0.25	0.25	22	4	2.5	20.0Min	0.56	100M-10G		4	
RI82-0.25	0.25	25	5	2.5	20.0Min	0.56	100M-10G		10	
RI82-0.5	0.5	35	5	2.5	24.0Max	0.56	100M-10G		15	
RI82-0.5	0.5	41	5	2.5	42.0Max	0.56	10M-1T		4	
RI82-1	1	25	10	2.5	30.0Max	0.56	100M-10G		15	
RI82-1	1	30	8	2.5	30.0Max	0.8	100M-10G		15	
RI82-1	1	33	8	2.5	35.0Max	0.56	100M-10G		20	
RI82-1	1	38	10	3	45.0Max	0.80	100M-1T		20	
RI82-2	2	38	10	3	40.0Max	0.80	100M-1T		20	
RI82-2	2	45	10	3	45.0Max	0.80	100M-10G		20	
RI82-3	3	50	10	3	45.0Max	0.80	100M-1T		20	
RI82-3	3	30	15	3	35.0Max	0.80	100M-10G		25	
RI82-3	3	60	10	3	55.0Max	0.80	100M-1T		25	
RI82-5	5	80	20	4	60.0Max	0.80	100M-200M		25	
RI82-10	10	97	23	4	80.0Max	0.80	100M-200M		30	
RI82-20	20	100	35	4	80.0Max	1	100M-200M		30	
RI82-30	30	100	48	4	80.0Max	1	100M-200M	30		

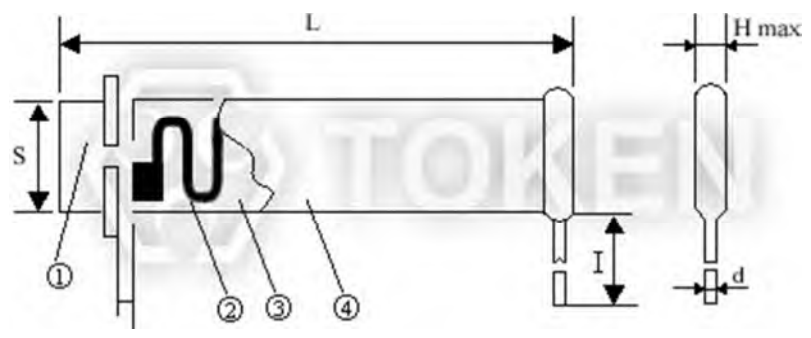

**B & C Style Dimensions - High Voltage Dip Type (RI82)**

- ① Silver Palladium Pole
- ② Resistive Film
- ③ 96% A1023 Ceramic Base
- ④ b style: Insulate Dielectric Glass;  
c style: High Temperature Silicone Resin

**Remark:**

- Rated Continus Working Voltage (RCWW) shall be determined from  $RCWW = \sqrt{\text{Power Rating} \times \text{Resistance Value}} \text{ (}\Omega\text{)}$  or Max.Working Voltage listed above , whichever two.



## ▶ Advance Technique

### Advance Technique of Non-Inductive & Serpentine Pattern (RI82)

#### Non-Inductive Performance:

- Token's RI82 Non-Inductive Design which uses a serpentine resistive pattern that offers for zigzagging lines to carry current in opposite directions, thereby neutralizing maximum of flux fields over the entire length of the resistor.
- This efficient non-inductive construction retains performance advantages and heavy load characteristics which is ideal for high frequency applications.



#### Serpentine Pattern Screen Printing Design:

- Type RI82 High Voltage Impulse Resistors combine Token's Non-Inductive serpentine pattern, high thru-put screen printed silicone coating.
- The alignment of the gap in the serpentine resistor pattern with the gap in the coating pattern provides a complete encapsulation of the resistor element.
- The lead assemblies are pressed onto the resistor core, finishing the resistor and providing rugged terminal attachment.

## ▶ Order Codes

### Order Codes (RI82)

RI82	0.125W	c	47M		K	
Part Number	Rated Power (W)	Style	Resistance Value ( $\Omega$ )		Resistance Tolerance (%)	
RI82	0.125W	a Style	4M7	4.7M $\Omega$	F	$\pm 1\%$
	0.25W	b Style	47M	47M $\Omega$	G	$\pm 2\%$
	0.5W	c Style	47M5	47.5M $\Omega$	J	$\pm 5\%$
	1W		470M	470M $\Omega$	K	$\pm 10\%$
					M	$\pm 20\%$

# High Voltage Power Resistors (RI85)

## ▶ Product Introduction

### Token High Voltage Resistors (RI85) Break Through 800 Wattage in High Power Applications.

#### Features :

- Max Working Voltage from 50KV to 100KV.
- Temperature Coefficient  $\leq 100$  ppm/ $^{\circ}$ C.
- Resistance Range from 100K $\Omega$  to 1Tera $\Omega$ .
- Resistance Tolerance K( $\pm 10\%$ ), M( $\pm 20\%$ ).
- Rated Wattage from 200W to 800W.

#### Applications :

- X-ray/imaging equipment,
- EMI/lightning suppression, Energy research,
- Pulse modulators, Radar Pulse-forming networks,
- Impulse voltage generators, Arc furnace damping,
- Capacitor crowbar circuits, High voltage snubber circuits.

Token Electronics RI85 series has been developed to provide design engineers with high quality, high power, and high voltage dividers for use in sophisticated system.

The RI85 resistors use Token's proprietary thick film metal glaze resistive element and Serpentine Pattern Design which provides ideal cost efficient, stability, high power and high voltage characteristics for a wide range of measurement, voltage divider circuits, and control functions in high voltage power electronics applications.

Token RI85 Voltage Power Resistors are able to absorb large amounts of energy at high voltage while remaining non-inductive and heavy load characteristics. RI85 Resistors conform to the RoHS directives and Lead-free. Customized design, low TCR, resistance values, and tighter tolerances are available on request.

The RI85 non-inductive metal glazed resistors are manufactured on proceeding of tube designed with tab terminal, thick-film printing, firing and laser trimming.

By utilizing specific ceramic core materials with optimum processing, Token are able to control, very tightly in manufacturing, the important ultra-stable performance parameters TCR less than 100 ppm/ $^{\circ}$ C. Voltage handles up to 100 KV and Wattage available 200W to 800W. This unique process is also offered in specific resistance values in a wide variety of sizes and terminations. The extraordinary operating stability of the Type RI85 resistors will improve the performance of your high voltage system.

The RI85 Power Voltage Series is RoHS compliant and lead free. For customized designs, tighter tolerances, non-standard technical requirements, or custom special applications, please contact us, or link to Token official website "[High Voltage Resistors](http://www.token.com.tw)" to get more information.



## ► Dimensions & Specification

### Dimensions & Specification (RI85) (Unit: mm)

Type	Power Rating	Resistance Value ( $\Omega$ )	Resistance Tolerance	Temperature Coefficient (PPM/ $^{\circ}$ C)	Dimensions (Unit: mm)					Max working voltage
					$\Phi D \pm 2$	$\Phi d \pm 2$	$L1 \pm 5$	$L2 \pm 5$	$T \pm 1$	
RI85	200W	100K~100G	10% (K) 20% (M)	$\leq 100$	28	15	185	200	10.5	50KV
RI85	500W	100K~500G		$\leq 100$	34	20	205	220	15	50KV
RI85	800W	100K~1T		$\leq 100$	55	40	205	220	15	100KV

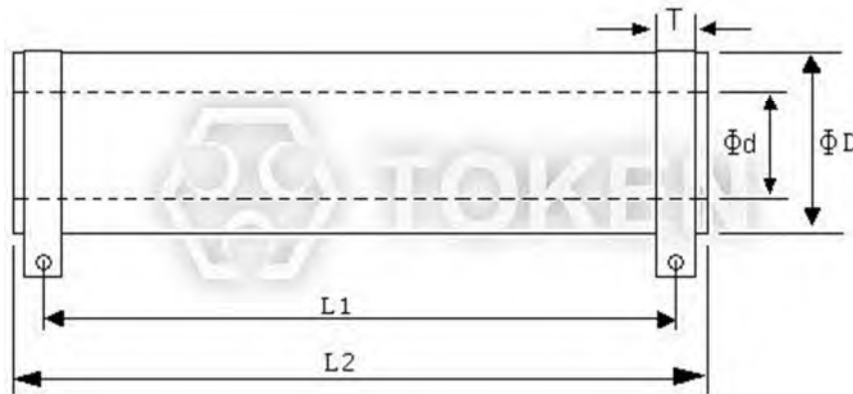

Tubular High Voltage Ceramic Resistors (RI85) Dimensions

- Remark: Rated Continuous Working Voltage (RCWV) shall be determined from  $RCWV = \text{square root} (\text{power rating} \times \text{resistance value})$  or Max Working Voltage listed above, whichever less.

## ▶ Derating Curve

### Power Derating Curve (RI85)

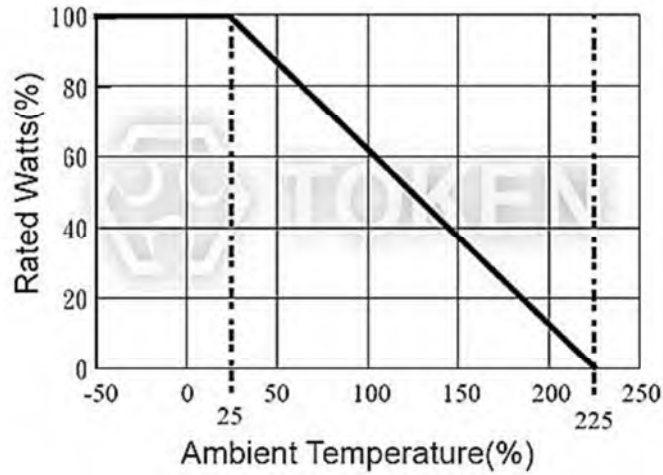

(RI85) Power Derating Curve

## ▶ Performance Specifications

### Performance Specifications (RI85)

Test Item	Test Methods	Characteristics
Moisture resistance	MIL Std. 202, method 106 (IEC68-2-3)	$\Delta R/R \leq \pm 0.1\%$ typ., 0.25% Max.
Insulation resistance	500V 25°C 75% relative humidity	10G $\Omega$ Min.
Dielectric strength	25°C 75% relative humidity	1000V Min.
Overload	1.5 $\times$ Pnom. 5 sec (do not exceed max. voltage)	$\Delta R/R \leq \pm 0.1\%$ typ., 0.25% Max.
Thermal shock	MIL Std. 202, method 107 Cond. C (IEC68-2-14)	$\Delta R/R \leq \pm 0.1\%$ typ., 0.2% Max.
Load life	1000h at rated power (IEC115-1)	$\Delta R/R \leq \pm 0.1\%$ typ., 0.25% Max.

## ▶ Advance Technique

### The Advantages of Non-Inductance & Serpentine Pattern - (RI85)

#### Non-Inductive Performance:

- RI85 Non-Inductive Design which uses a serpentine resistive pattern that offers for zigzagging lines to carry current in opposite directions, thereby achieving maximum neutralization of flux fields over the entire length of the resistor.
- This efficient non-inductive construction without derating of any performance advantages is ideal for applications where high frequency is required.



#### Serpentine Pattern Screen Printing Design:

- The RI85 High Voltage Power Resistor combines Token's Non-Inductive serpentine pattern, high thru-put screen printed silicone coating.
- The alignment of the gap in the serpentine resistor pattern with the gap in the coating pattern provides a complete encapsulation of the resistor element.
- The cap and lead assemblies are pressed onto the resistor core, finishing the resistor and providing rugged terminal attachment.

## ▶ Order Codes

### High Voltage Resistors (RI85)

RI85	200W	1M	K
Product Type.	Rated Power.(W)	Resistance Value. ( $\Omega$ )	Resistance Tolerance.



# High Voltage Network Dividers (NTK)

## ► Product Introduction

**Token High Voltage Resistor Network Dividers can be customized to order.**

### Specifications :

- Resistance Range: 1K $\Omega$  ~ 10G $\Omega$ .
- Resistance Tolerance:  $\pm 1\%$  ~  $\pm 30\%$ .
- Thick film on Aluminum > 96% Al<sub>2</sub>O<sub>3</sub>.
- High Voltage Withstanding: Up to 30 ~ 50KV.
- Low VCR: 1ppm / 5ppm / 10ppm upon request.
- Temperature Range: -55 $^{\circ}$ C ~ +125 $^{\circ}$ C (higher temp. upon request).
- Low TCR Available: 250 ppm/ $^{\circ}$ C. (ppm/ $^{\circ}$ C or tighter upon request).

### Features :

- Flat style, Low Resistor Noise.
- Non Inductive Design.
- Divider Design upon Request.
- Pb-free Production: Meet RoHS.
- Different Coating Available: Glass / Epoxy resin / Silicon.
- Solderable Leads (Tin coated copper leads): Type  $\Phi 0.5$  ( $\Phi 0.6$  /  $\Phi 0.8$  upon request).

RoHS-compliant resistor network, high-value high-voltage resistors and potential dividers in a wide variety of configurations are now available from Token Electronics as custom versions of its standard ranges of resistive products.

This advanced film resistor technology provides the performance characteristics required by the precision input signal circuits of both bench-type and laboratory digital instruments. In addition to requiring less board space, these compact voltage network dividers deliver higher performance than selected discrete resistor sets and thin-film dividers.

Manufactured using advance thick-film technology from existing tooling ensures fast turnaround of samples prior to low to medium volume in-house production. These custom dividers are ideal for high performance voltage division applications in medical equipment, laboratory equipment, analytical instruments, etc. The custom high voltage network divider can be supplied in various packages and packaging materials including glass, epoxy resin, silicon options.

By applying this technology to the low-profile, single-in-line package configuration, the Type (NTK) Custom SIP Resistor Networks are available with a combination of features. Which include: Low TCR 250 ppm/ $^{\circ}$ C (100 ppm/ $^{\circ}$ C or tighter upon request), operating temperature range -55 $^{\circ}$ C ~ +125 $^{\circ}$ C (higher temperature upon request), flat style, non-inductive, low noise, and also custom divider design.

For complete information on quantity price and delivery, please contact our Sales Office, or link to Token official website "[High Voltage Resistors](http://www.token.com.tw)" to get more information.





## ▶ NTK-A Electrical Parameters

### Electrical Parameters (NTK-A)

Type	PIN	Resistance Value ( $\Omega$ )		Resistance Tolerance	Pressure parameters	Rated Power (W)
NTK-A	1~2	R1	30M	K ( $\pm 10\%$ )	4KV Min.	0.6W Min.
	2~3	R2	30M	K ( $\pm 10\%$ )	4KV Min.	0.6W Min.
	3~4	R3	1M	J ( $\pm 5\%$ )	500V Min.	0.3W Min.
	4~5	R4	800M	K ( $\pm 10\%$ )	10KV Min.	1W Min.

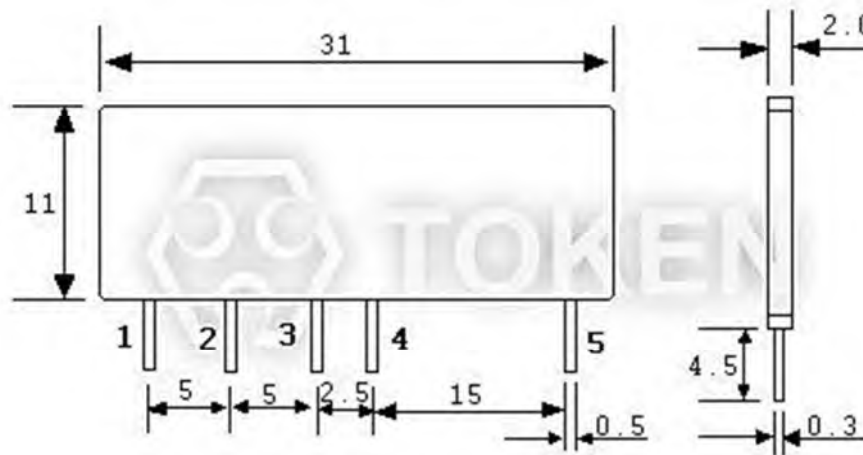

High Voltage Divider Network (NTK-A) Series Dimensions

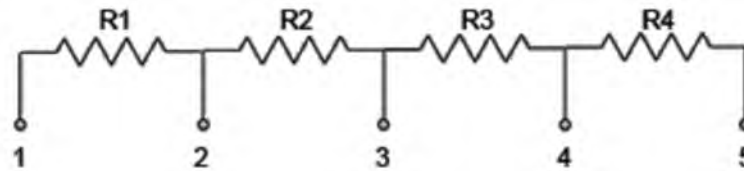

## ► NTK-B Electrical Parameters

### Electrical Parameters (NTK-B)

Type	Serial Number	Resistance Value ( $\Omega$ )	Rated Power	Resistance Tolerance	Temperature Coefficient	Operating Voltage
NTK-B	R1	52M	5W	$\pm 5\%$	$\pm 250\text{PPM}/^\circ\text{C}$	8500V
	R2	10K	-			-
	R3	10K	-			-
	R4	16M2	4W			4200V
	R5	17M3	3W			4400V
	R6	3M3	1W			800V
	R7	8K	-			-

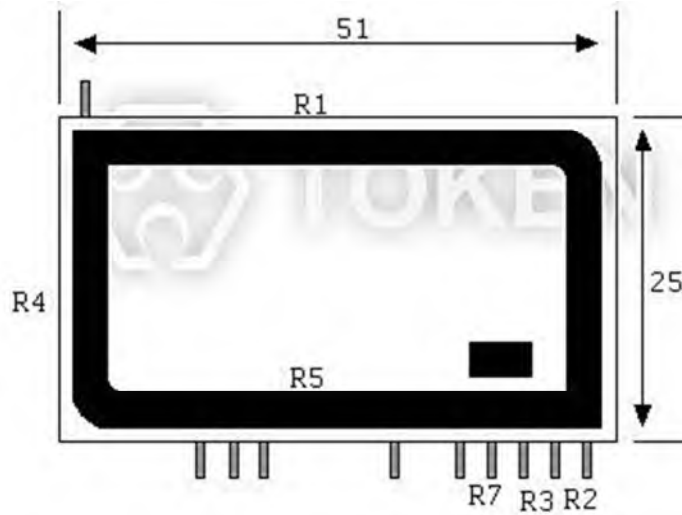

High Voltage Divider Network (NTK-B) Series Dimensions

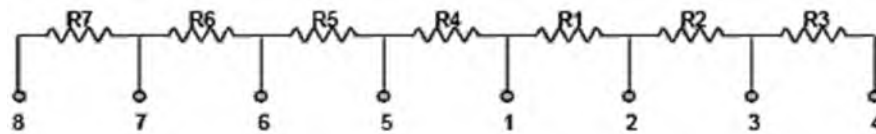

# Thick Film Planar Dividers, High Voltage Resistors (HI83)

## ► Product Introduction

Token electronic printing technology to achieve a superior precision, thick film planar high voltage dividers.

### Features :

- High precision, Non-Inductance design.
- High voltage, Wide range of resistance.
- Custom design services. RoHS compliant.

### Applications :

- Pulse Modulator, Radar Pulse Forming Network.
- X-ray/Imaging Equipment, and EMI lightning suppression.
- Capacitor Arc Suppression Circuit, High Voltage Buffer Circuit.
- Impulse Voltage Generator. Electric Arc Furnace Damping, Energy Research.

Through-hole (HI83) thick film planar divider, high voltage resistor series is a new generation of Token Electronic Technology Co., Ltd. Taking advantage of high-quality ruthenium oxide resistance material to 96% alumina planar ceramic matrix, dividers (HI83) features good thermal conductivity, small size, and high reliability. Custom dividers available with leadwire terminals or with leadless conductive pads.



The planar thick film divider resistor (HI83) provides stable performance over a wide range of resistance values with a voltage rating up to 35KV. The maximum resistance ratio is 1000: 1 (ratio greater than 1000: 1, such as 2000: 1, 4000: 1, and 5000: 1 is available on request) with a minimum resistance ratio of 40: 1.

Low temperature coefficient can be used for high stability circuit applications. Space-saving planar packages provide an alternative to traditional high-voltage resistors. (HI83) is mainly used in precision instruments, drive circuits, power supplies, transformers, high voltage power equipment, and any need to operate in high voltage electrical appliances and other fields.

The main structure of the planar thick film voltage divider (HI83): The terminal connecting conductor and the ruthenium oxide resistive material were printed on the surface of the 96% alumina substrate in a non-inductive pattern. Then apply the screen printing protection, after connect the terminals. Phosphor bronze solder is welded to the lead frame terminal and is immersed in SnAgCu to meet the following IEC weldability requirements.

Thick film (HI83) voltage dividers are RoHS compliant and 100% lead free. For conventional parameters, specifications outside the parameters, or technical requirements, please contact Token, or link to Token official website "[High Voltage Resistors](http://www.token.com.tw)" to get more information.



## General Specifications

### Composition Structure (HI83)

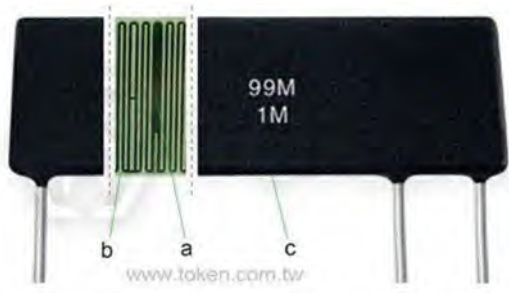
	Membrane Material (a)	Ruthenium Paste
	Base Material (b)	95% Aluminum Oxide, Al <sub>2</sub> O <sub>3</sub>
	Encapsulating Material (c)	High Temperature Silicone Resin

### Dimension Specifications (Unit: mm) (HI83)

Part Number	Power Rating (W)	Max. Working Voltage (KV)	L ±0.5 mm	W ±0.5 mm	P ±1 mm	D ±0.5 mm	I ±1 mm	T ±0.5 mm	t ±0.05 mm
HI83-04	1/4W	10	25	5	22.6	4	20	2	0.6
HI83-02	1/2W	15	35	5	32	5	20	2	0.6
HI83-10	1W	15	38	8	27	6	20	2	0.6
HI83-20	2W	20	45	10	42	6	20	2	0.6
HI83-30	3W	25	60	10	59	8	40	3.5	1
HI83-50	5W	30	80	20	76.5	10	40	3.5	1

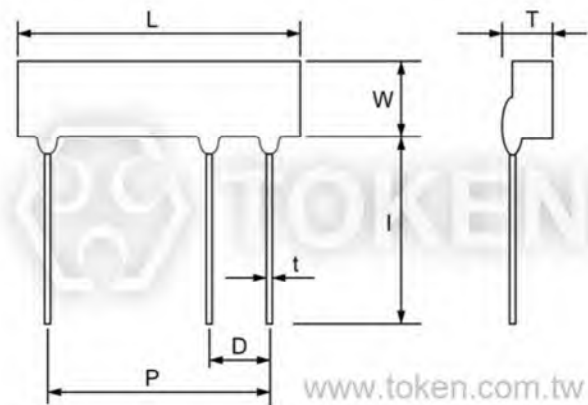
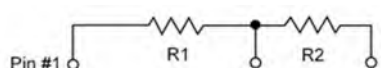
	
<p>Divider Dimension Specifications (Unit: mm) - (HI83)</p>	

## Electrical Characteristics

### Technical Characteristics - (HI83)

Part Number	HI83-04	HI83-02	HI83-10	HI83-20	HI83-30	HI83-50
Power rating at 70°C (W)	1/4W	1/2W	1W	2W	3W	5W
Limiting element voltage in air dc or ac pk (KV)	6KV	10KV	15KV	15KV	20KV	25KV
Resistance value (Ω)	10K-1G	50K-1G	100K-1G	100K-1G	100K-1G	100K-1G
Resistance tolerance (%)	1, 5					
Ratio tolerance (%)	0.25, 0.5, 1					
TCR (20°C to 70°C) (ppm/°C)	50, 100					
Tracking TCR (20°C to 70°C) (ppm/°C)	25, 50					
Standard values	E24 preferred for (R1 + R2) and R2					
Ambient temperature range (°C)	-55 to +125					
Insulation resistance at 500V (Ω)	>10G					
Dielectric strength of insulation (V)	>1000					

## Environmental Characteristics

### Environmental characteristics - (HI83)

Test Items	Condition	Spec.
Resistance Temp. Coeff.	-55°C ~ 125°C	±200 ~ ±300 ppm/°C
Overload	1.5 times of rated voltage, 15 min (do not exceed max. voltage)	$\Delta R \leq \pm(1\%R + 0.05\Omega)$
Load Life	96 hours at rated power	$\Delta R \leq \pm(1\%R + 0.1\%\Omega)$

### Derating Curve

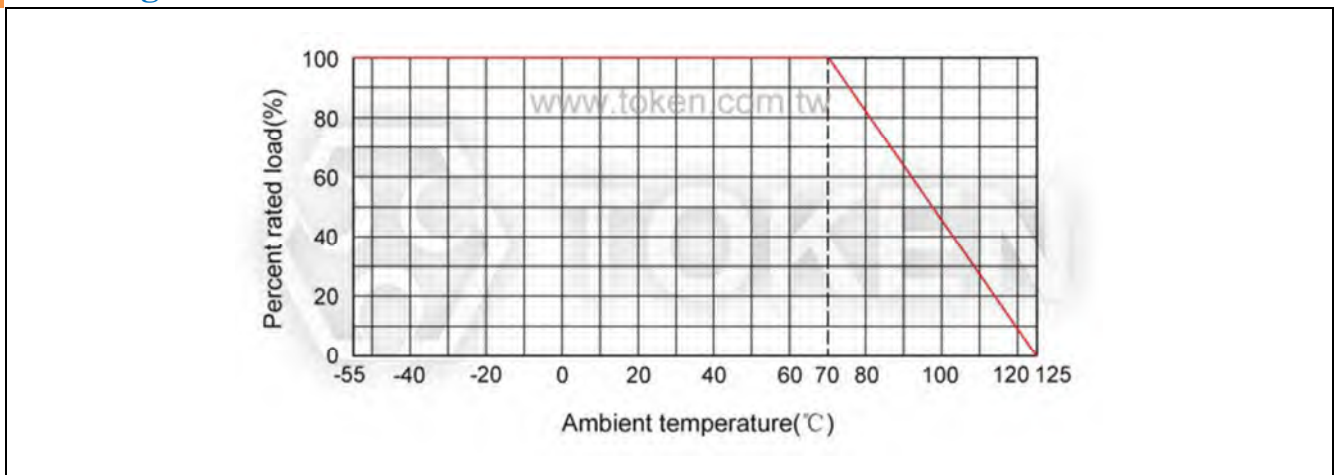



## ► Serpentine Pattern

### Advance Technique of Non-Inductive & Serpentine Pattern (HI83)

#### Non-Inductive Performance:

- HI83 Non-Inductive Design which uses a serpentine resistive pattern that offers for zigzagging lines to carry current in opposite directions, thereby achieving maximum neutralization of flux fields over the entire length of the resistor.
- This efficient non-inductive construction without derating of any performance advantages is ideal for applications where high frequency is required.



#### Serpentine Pattern Screen Printing Design:

- Type High Voltage HI83 Precision Resistors combine Token's Non-Inductive serpentine pattern, high thru-put screen printed silicone coating.
- The alignment of the gap in the serpentine resistor pattern with the gap in the coating pattern provides a complete encapsulation of the resistor element.
- The cap and lead assemblies are pressed onto the resistor core, finishing the resistor and providing rugged terminal attachment.

## ► Application Notes

### High Voltage Divider Application Notes (HI83)

- Due to the high voltage that may occur between the terminals and any adjacent metal parts, the voltage divider should be installed at a sufficient distance from other conductors.
- For some ultra-high voltage applications, it is necessary to immerse the component in oil or SF6 gas or place it in a void-free silicone compound to reduce surface tracking or corona. The printed protection is right for these applications.
- The planar voltage divider consists of high value R1 and low value R2. The voltage division ratio of the divider is specified by Ratio R2: (R1 + R2).





## Order Codes

### Order Codes (HI83)

Example:

HI83-20 for a voltage ratio of 1:1000, with R1 = 99.9 megohms and R2 = 100 kilohms (total R1 + R2 = 100 megohms) at 50ppm/°C absolute and 25ppm/°C tracking TCR, 1% absolute and 0.5% ratio tolerance.

HI83	20		C2C3		100M		100K		FD	
Part Number	Size		TCR (ppm/°C)		R1 + R2 (Ω)		R2 (Ω)		Resistance Tolerance (%)	
HI83	04	1/4W	C1C2	100ppm absolute and 50ppm tracking	100M	99MΩ + 1MΩ	1M	1MΩ	JF	5% absolute and 1% ratio
	02	1/2W								
	10	1W	C1C3	100ppm absolute and 25ppm tracking	100M	99.9MΩ + 100KΩ	1M5	1.5MΩ	FD	1% absolute and 0.5% ratio
	20	2W								
	30	3W	C2C3	50ppm absolute and 25ppm tracking	150M	148.5MΩ + 1.5MΩ			FC	1% absolute and 0.25% ratio
	50	5W								



# Precision High-Megohm High-Value Chip Resistors (HM)

## ► Product Introduction

**Token (HM) non-magnetic chip resistor providing high resistance value and high-temperature application performance.**

### Features :

- Non-magnetic.
- Non-standard values available.
- Low temperature and voltage dependency.
- Contact areas PtAg for glueing and soldering.
- Untrimmed for higher working voltage up to 6000V.

### Packaging :

- Halogen-free, compliant to RoHS directive 2002/95/EC.
- Bulk in plastic bags or tubes - MOQ 100 pieces.
- Blister tape IEC60286-3 - MOQ 1000 pieces. Reel diameter 180mm or 330mm.

Token non-magnetic SMD resistor (HM) series, applied to the field of medical high magnetic fields, such as electronic circuits located in magnetic resonance (MRI) and computed tomography (CT), or in the extreme environment of oil and gas industries, such as downhole instruments for oil wells, or flight control in aerospace applications.

(HM) SMD Resistor series its junction area does not contain nickel, they are made of metal alloy PtAg, can be used as thick film slurry, suitable for roll coating or impregnation process to the packaging chipset parts area. The standard SMD soldering process can also be used in the bonding process of silver conductive epoxy resins. The bonding technology of conductive epoxy resin is mainly used in the case of welding technology can not be applied, such as the temperature sensitive component which is affected by the high welding temperature, or the semiconductor without cladding on the same board. PtAg terminals are suitable for high temperature welding applications, which can be higher than the 155°C of typical soldering.

Similarly, (HM) chip resistors do not contain organic materials, no tin or tin lead layer, and resistance and conductive layer at 850°C high-temperature sintering, so the resistor chip will not have a substantial change, and has a stable electrical characteristics. The terminal material also affects the VCR (the voltage coefficient of the resistor), which is an important characteristic of the high-voltage resistor, and lower VCR is also designed for the Token of the non-magnetic SMD resistor.

Token non-magnetic thick flim chip resistor (HM) series, it consists of two main categories: (HMM) Precision High Value Chips and (HMS) Conventional Precision Megohm Chips. Sizes are 0402, 0603, 0805, 1206, 1210, 2512, and 4020 available. Resistance range from 100KΩ to the highest value 10TΩ. Operating voltage can reach 6000V. Precision tolerance has 0.25%/0.5%/1%/2%/5%/10%/20%/30% alternative. The temperature coefficient is low to 25ppm/°C. The voltage factor VCR can be specified within the range, from low to 25ppm/v.

(HM) chips compliant with RoHS and lead-free standards. Provide more competitive prices and fast delivery services. For technical requirements and special applications outside the specification, please contact the business representative of the Token Electronics, or link to Token official website "[High Voltage Resistors](http://www.token.com.tw)" to get more information.



## Dimensions

### Precision Non-magnetic Chip Dimensions (Unit: mm)

(HMM) Precision High Value Chip Resistors				
Part Number	L (mm)	W (mm)	T (mm)	D (mm)
HMM-0805	2.00 <sup>+0.15/-0.05</sup>	1.25 <sup>+0.15/-0.05</sup>	0.40 <sup>+0.15/-0.05</sup>	0.30 <sup>+0.20/-0.10</sup>
HMM-1206	3.20 <sup>+0.15/-0.05</sup>	1.50 <sup>+0.20/-0.05</sup>	0.40 <sup>+0.15/-0.05</sup>	0.30 <sup>+0.20/-0.10</sup>
HMM-1210	3.20 <sup>+0.15/-0.05</sup>	2.50 <sup>+0.20/-0.05</sup>	0.50 <sup>+0.15/-0.05</sup>	0.80 <sup>±0.20</sup>
HMM-2010	5.10 <sup>+0.15/-0.05</sup>	2.50 <sup>+0.20/-0.05</sup>	0.60 <sup>+0.20/-0.10</sup>	1.20 <sup>±0.20</sup>
HMM-2512	6.30 <sup>+0.15/-0.05</sup>	3.50 <sup>+0.20/-0.05</sup>	0.60 <sup>+0.15/-0.05</sup>	0.90 <sup>±0.20</sup>
HMM-4020	10.20 <sup>+0.20/-0.05</sup>	5.10 <sup>+0.20/-0.05</sup>	0.60 <sup>+0.20/-0.10</sup>	0.90 <sup>±0.20</sup>

Note: L = Length, H = Width, T = Thickness, D = width of wrap around ◦

(HMS) Conventional Precision Megohm Chip Resistors				
Part Number	L (mm)	W (mm)	T (mm)	D (mm)
HMS-0402	1.04 <sup>±0.05</sup>	0.50 <sup>±0.05</sup>	0.30 <sup>±0.05</sup>	0.10 <sup>+0.10/-0.05</sup>
HMS-0603	1.50 <sup>+0.15/-0.05</sup>	0.80 <sup>+0.15/-0.05</sup>	0.40 <sup>+0.15/-0.05</sup>	0.20 <sup>+0.20/-0.10</sup>
HMS-0805	2.00 <sup>+0.15/-0.05</sup>	1.25 <sup>+0.15/-0.05</sup>	0.40 <sup>+0.15/-0.05</sup>	0.30 <sup>+0.20/-0.10</sup>
HMS-1206	3.20 <sup>+0.15/-0.05</sup>	1.50 <sup>+0.20/-0.05</sup>	0.40 <sup>+0.15/-0.05</sup>	0.30 <sup>+0.20/-0.10</sup>
HMS-1210	3.20 <sup>+0.15/-0.05</sup>	2.50 <sup>+0.20/-0.05</sup>	0.50 <sup>+0.15/-0.05</sup>	0.80 <sup>±0.20</sup>
HMS-2512	6.30 <sup>+0.15/-0.05</sup>	3.50 <sup>+0.20/-0.05</sup>	0.60 <sup>+0.15/-0.05</sup>	0.90 <sup>±0.20</sup>
HMS-4020	10.20 <sup>+0.15/-0.05</sup>	5.10 <sup>+0.20/-0.05</sup>	0.60 <sup>+0.15/-0.05</sup>	0.90 <sup>±0.20</sup>

Note: L = Length, H = Width, T = Thickness, D = width of wrap around ◦

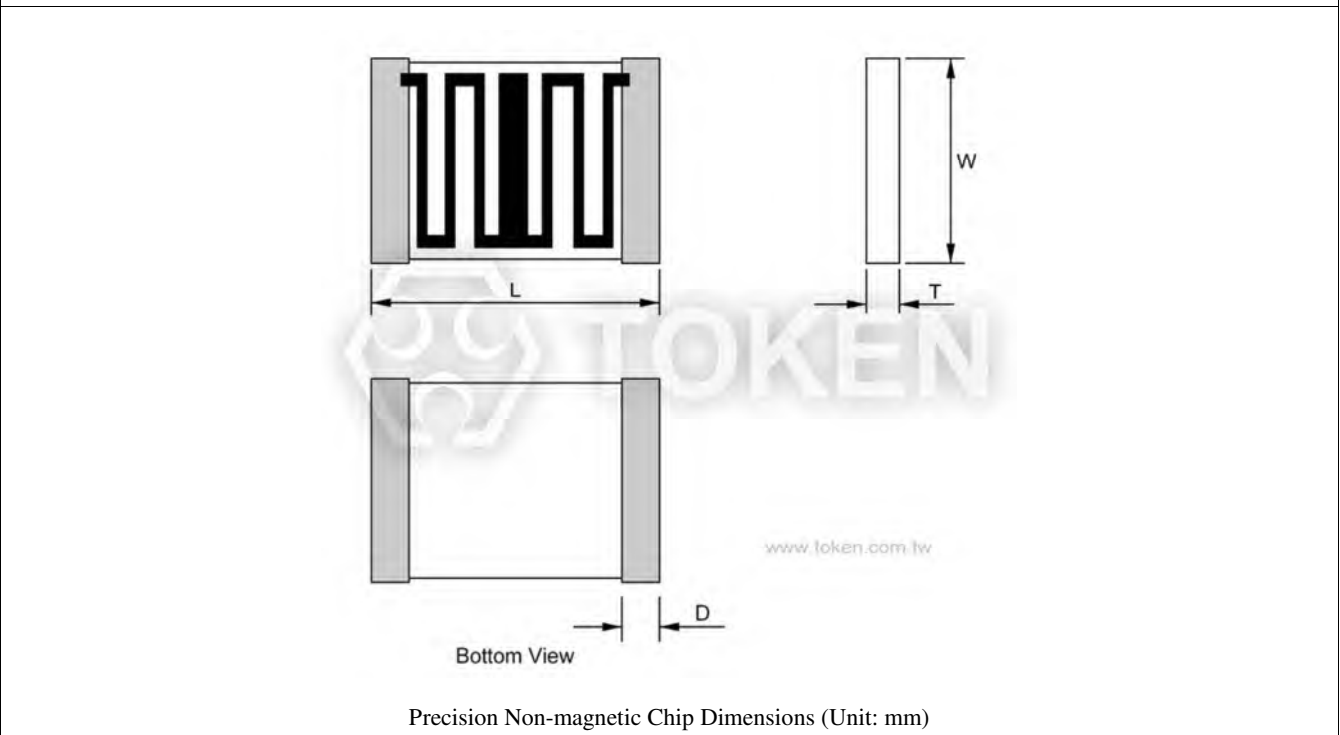

## ► HMM Electrical characteristics

### Technical Characteristics - (HMM)

Part Number	Power Rating P <sub>70</sub> (mW)	Working Voltage (V)		Resistance Range (Ω)	Tolerance (%)	TCR <sup>(2)</sup> (ppm/°C)	VCR <sup>(3)</sup> (ppm/V)
		trimmed	untrimmed				
HMM-0805	125	200	600	100K - 100M	0.5/1/5/10	TC25/50/100	<50ppm/V
				>100M - 1G	2/5/10/20	TC50/100/250	<250ppm/V
				>1G - 10G	5/10/20	TC100/250	<500ppm/V
				>10G - 100G	10/20/30	TC1000/2000	<1000ppm/V
				>100G - 1T	-	-	-
				>1T - 10T	-	-	-
HMM-1206	250	600	1000	100K - 100M	0.5/1/2/5/10	TC25/50/100	<50ppm/V
				>100M - 1G	2/5/10/20	TC50/100/250	<100ppm/V
				>1G - 10G	5/10/20	TC100/250	<250ppm/V
				>10G - 100G	10/20/30	TC500/1000	<1000ppm/V
				>100G - 1T	10/20/30	TC1000/2000	<2000ppm/V
				>1T - 10T	-	-	-
HMM-1210	350	1000	1200	100K - 100M	0.5/1/2/5/10	TC25/50/100	<25ppm/V
				>100M - 1G	1/2/5/10/20	TC25/50/100	<50ppm/V
				>1G - 10G	2/5/10/20	TC50/100	<100ppm/V
				>10G - 100G	5/10/20/30	TC500/1000	<500ppm/V
				>100G - 1T	5/10/20/30	TC500/1000	<1000ppm/V
				>1T - 10T	-	-	-
HMM-2010	500	1500	2000	100K - 100M	0.5/1/2/5/10	TC25/50/100	<25ppm/V
				>100M - 1G	1/2/5/10/20	TC25/50/100	<50ppm/V
				>1G - 10G	2/5/10/20	TC50/100	<100ppm/V
				>10G - 100G	5/10/20/30	TC250/500	<500ppm/V
				>100G - 1T	5/10/20/30	TC500/1000	<1000ppm/V
				>1T - 10T	-	-	-
HMM-2512	1000 <sup>(1)</sup>	2000	3000	100K - 100M	0.5/1/2/5/10	TC25/50/100	<10ppm/V
				>100M - 1G	1/2/5/10/20	TC25/50/100	<25ppm/V
				>1G - 10G	2/5/10/20	TC500/100	<100ppm/V
				>10G - 100G	5/10/20/30	TC250/500	<250ppm/V
				>100G - 1T	5/10/20/30	TC500/1000	<500ppm/V
				>1T - 10T	10/20/30	TCR VCR	on request
HMM-4020	1500 <sup>(1)</sup>	4000	6000	100K - 100M	0.25/.../10	TC25/50/100	<10ppm/V
				>100M - 1G	0.5/.../20	TC25/50/100	<10ppm/V
				>1G - 10G	1/2/5/10/20	TC25/50/100	<25ppm/V
				>10G - 100G	2/5/10/20/30	TC250/500	<100ppm/V
				>100G - 1T	5/10/20/30	TC500/1000	<250ppm/V
				>1T - 10T	10/20/30	TCR VCR	on request

**Note:**

- <sup>(1)</sup> At continuous power dissipation the dimensions of solder-pads have to secure sufficient heat-conduction.
- <sup>(2)</sup> TCR 25/50: Temperature range +25°C ~ +85°C ; <sup>(3)</sup> VCR: Typical values.
- Lower values of tolerance, TCR and VCR on request and agreement.



## Environmental Characteristic

Temperature range	-55°C ~ +155°C		
Climatic category acc. to IEC 60068	55/155/56		
Max. soldering temperature acc. IEC60068 T2-20, Ta Meth.1 <sup>(4)</sup>	235°C 5s		
Max. soldering temperature acc. IEC60068 T2-20, Tb Meth.1A	260°C 10s		
Long term stability	<1G	<10G	≥10G
Storage 125°C/1000h	<0.5%	<1%	<2%
Load life 70°C/1000h	<0.25%	<0.5%	<1%

**Note:**

- <sup>(4)</sup> Up to 6 months after shipment resp, at storage in Nitrogen.
- Data not specified according CECC 40401-802.





## ► HMS Electrical characteristics

### Technical Characteristics - (HMS)

Part Number	Power Rating P <sub>70</sub> (mW)	Working Voltage (V)		Resistance Range (Ω)	Tolerance (%)	TCR <sup>(2)</sup> (ppm/°C)	VCR <sup>(3)</sup> (ppm/V)
		trimmed	untrimmed				
HMS-0402	50	30	90	1M - 100M	5/10/20	TC100/250	<500ppm/V
				>100M - 500M	5/10/20	TC250/500	<1000ppm/V
				>500M - 1G	5/10/20	TC250/500	<1000ppm/V
				>1G - 10G	10/20/30	TC1000/2000	<2000ppm/V
				>10G - 100G	-	-	-
				>100G - 1T	-	-	-
HMS-0603	75	75	200	1M - 100M	1/5/10/20	TC100/250	<250ppm/V
				>100M - 500M	2/5/10/20	TC100/250	<250ppm/V
				>500M - 1G	5/10/20	TC250/500	<500ppm/V
				>1G - 10G	5/10/20/30	TC500/1000	<2000ppm/V
				>10G - 100G	10/20/30	TC1000/2000	<5000ppm/V
				>100G - 1T	-	-	-
HMS-0805	125	100	300	1M - 100M	1/5/10/20	TC50/100	<100ppm/V
				>100M - 500M	2/5/10/20	TC100/250	<250ppm/V
				>500M - 1G	5/10/20	TC250/500	<250ppm/V
				>1G - 10G	5/10/20	TC500/1000	<1000ppm/V
				>10G - 100G	10/20/30	TC1000/2000	<2000ppm/V
				>100G - 1T	10/20/30	TC3000	<5000ppm/V
HMS-1206	250	200	600	1M - 100M	1/5/10/20	TC25/50/100	<100ppm/V
				>100M - 500M	2/5/10/20	TC50/100/250	<100ppm/V
				>500M - 1G	5/10/20	TC100/250	<250ppm/V
				>1G - 10G	5/10/20	TC500/1000	<1000ppm/V
				>10G - 100G	10/20/30	TC1000/2000	<2000ppm/V
				>100G - 1T	10/20/30	TC3000	<5000ppm/V
HMS-1210	350	300	900	1M - 100M	1/5/10/20	TC25/50/100	<50ppm/V
				>100M - 500M	2/5/10/20	TC50/100/250	<100ppm/V
				>500M - 1G	5/10/20	TC100/250	<100ppm/V
				>1G - 10G	5/10/20	TC250/500	<500ppm/V
				>10G - 100G	5/10/20	TC500/1000	<1000ppm/V
				>100G - 1T	5/10/20/30	TC1000/2000	<2000ppm/V
HMS-2512	1000 <sup>(1)</sup>	1000	2000	1M - 100M	1/.../20	TC25/50/100	<10ppm/V
				>100M - 500M	1/5/10/20	TC25/50/100	<25ppm/V
				>500M - 1G	1/5/10/20	TC100/250	<25ppm/V
				>1G - 10G	2/5/10/20	TC250/500	<100ppm/V
				>10G - 100G	5/10/20	TC250/500	<250ppm/V
				>100G - 1T	5/10/20	TC500/1000	<500ppm/V
HMS-4020	1500 <sup>(1)</sup>	4000	6000	1M - 100M	1/.../10	TC25/50/100	<5ppm/V
				>100M - 500M	0.5/1/5/10/20	TC25/50/100	<10ppm/V
				>500M - 1G	1/5/10/20	TC25/50/100	<10ppm/V
				>1G - 10G	2/5/10/20	TC50/100	<25ppm/V
				>10G - 100G	5/10/20/30	TC100/250	<100ppm/V
				>100G - 1T	5/10/20/30	TC250/500	<250ppm/V

**Note:**

- <sup>(1)</sup> At continuous power dissipation the dimensions of solder-pads have to secure sufficient heat-conduction.
- <sup>(2)</sup> TCR 25/50: Temperature range +25°C ~ +85°C ; <sup>(3)</sup> VCR mesdured between 10V and 100V.
- Lower values of tolerance, TCR and VCR on request and agreement.





## Environmental Characteristic

Temperature range	-55°C ~ +155°C		
Climatic category acc. to IEC 60068	55/155/56		
Max. soldering temperature acc. IEC60068 T2-20, Ta Meth.1 <sup>(4)</sup>	235°C 5s		
Max. soldering temperature acc. IEC60068 T2-20, Tb Meth.1A	260°C 10s		
Long term stability	<1G	<10G	≥10G
Storage 125°C/1000h	<1%	<2%	<5%
Load life 70°C/1000h	<0.5%	<1%	<2%

**Note:**

- <sup>(4)</sup> Up to 6 months after shipment resp, at storage in Nitrogen.
- Data not specified according CECC 40401-802.



## Order Codes

### Order Codes (HMM) - Precision High Value Chip Resistors

HMM	0805		1G		M		E	
Part Number	Rated Power (W)		Resistance Value ( $\Omega$ )		Resistance Tolerance (%)		TCR (ppm/ $^{\circ}$ C)	
HMM	0805	125mW	1M1	1.1M $\Omega$	C	$\pm 0.25\%$	C	$\pm 25\text{ppm}/^{\circ}\text{C}$
	1206	250mW	110M	110M $\Omega$	D	$\pm 0.5\%$	D	$\pm 50\text{ppm}/^{\circ}\text{C}$
	1210	350mW	1G5	1.5G $\Omega$	F	$\pm 1\%$	E	$\pm 100\text{ppm}/^{\circ}\text{C}$
	2010	500mW	10G	10G $\Omega$	G	$\pm 2\%$	L	$\pm 250\text{ppm}/^{\circ}\text{C}$
	2512	1000mW	1T	1T $\Omega$	J	$\pm 5\%$	I	$\pm 500\text{ppm}/^{\circ}\text{C}$
	4020	1500mW	10T	10T $\Omega$	K	$\pm 10\%$	R	$\pm 1000\text{ppm}/^{\circ}\text{C}$
					M	$\pm 20\%$	S	$\pm 2000\text{ppm}/^{\circ}\text{C}$
					N	$\pm 30\%$		

### Order Codes (HMS) - Conventional Precision Megohm Chip Resistors

HMS	0402		1G		M		E	
Part Number	Rated Power (W)		Resistance Value ( $\Omega$ )		Resistance Tolerance (%)		TCR (ppm/ $^{\circ}$ C)	
HMS	0402	50mW	1M1	1.1M $\Omega$	D	$\pm 0.5\%$	C	$\pm 25\text{ppm}/^{\circ}\text{C}$
	0603	75mW	110M	110M $\Omega$	F	$\pm 1\%$	D	$\pm 50\text{ppm}/^{\circ}\text{C}$
	0805	125mW	1G5	1.5G $\Omega$	G	$\pm 2\%$	E	$\pm 100\text{ppm}/^{\circ}\text{C}$
	1206	250mW	10G	10G $\Omega$	J	$\pm 5\%$	L	$\pm 250\text{ppm}/^{\circ}\text{C}$
	1210	350mW	1T	1T $\Omega$	K	$\pm 10\%$	I	$\pm 500\text{ppm}/^{\circ}\text{C}$
	2512	1000mW			M	$\pm 20\%$	R	$\pm 1000\text{ppm}/^{\circ}\text{C}$
	4020	1500mW			N	$\pm 30\%$	S	$\pm 2000\text{ppm}/^{\circ}\text{C}$
							T	$\pm 3000\text{ppm}/^{\circ}\text{C}$

- Note: If no requirements for TCR, measuring voltage and taping are given, the standard value (highest value in table) will be supplied, measuring voltage of 10V is used and packaging is bulk.

## Ultra-Precision High-Power High-Voltage Resistors (HI80)

### ► Product Introduction

**New ruthenium material, extended ultra-precision high-power high-voltage resistors (HI80) breakthrough 300W, precision narrowed to 0.1%.**

#### Features :

- Thick film sensorless design.
- Wide range of resistance.
- Bottom temperature coefficient and high precision.
- Resistance to humidity, heat and electricity.
- Long term performance, stable and reliable.

#### Applications :

- Impulse voltage generators,
- Arc furnace damping, Energy research,
- Pulse modulators, Radar Pulse-forming networks,
- Capacitor crowbar circuits, High voltage snubber circuits,
- X-ray/imaging equipment, and EMI/lightning suppression.

Token electronic ultra-precision high-power high-voltage resistor (HI80) family series take advantage of new ultra-fine ruthenium material, 95% aluminum oxide ceramic rods, and thick film non-inductive Serpentine Pattern Design. Precision can be narrowed to  $\pm 0.1\%$ , and power breakthrough 300W. (HI80) featuring heat-resistant, humidity-resistant, resisting electrical pulse, and stable and reliable long-term performance, is specifically designed for general purpose industrial high voltage system applications.



(HI80) family of high-voltage resistors includes conventional high-voltage resistors (HI80D), conventional miniaturized high-voltage resistors (HI80DS), high-power high-voltage resistors (HI80P), and ultra-precision high-voltage resistors (HI80T).

Conventional high voltage resistors (HI80D) have a wide resistance range of  $200\Omega \sim 10G\Omega$ , rated power 2.5W ~ 20W, accuracy tolerance F ( $\pm 1\%$ ), J ( $\pm 5\%$ ), K ( $\pm 10\%$ ), the lowest temperature coefficient down to 50ppm on request, and the standard temperature coefficient of 100ppm.

(HI80DS) All-film conventional miniature high-voltage resistor relative to (hi80d), with small size, higher power 3W ~ 30W, withstand higher voltage, and none-inductance. The temperature coefficient of the lowest can reach 50ppm ( $25^{\circ}\text{C} \sim 105^{\circ}\text{C}$ ), the standard temperature coefficient of 100ppm. Precision Tolerances F ( $\pm 1\%$ ), J ( $\pm 5\%$ ), K ( $\pm 10\%$ ).

High power high voltage resistors (HI80P) have high rated power 20W ~ 300W, resistance range  $1\Omega \sim 1G\Omega$ , precision tolerance D ( $\pm 0.5\%$ ), F ( $\pm 1\%$ ), J ( $\pm 5\%$ ), K ( $\pm 10\%$ ), The temperature coefficient of up to 25ppm (on request), the standard temperature coefficient of 50ppm.

Ultra-precision high-voltage resistor (HI80T) characters 15ppm temperature coefficient, the standard temperature coefficient is 25ppm, the precision tolerance has B ( $\pm 0.1\%$ ), D ( $\pm 0.5\%$ ), F ( $\pm 1\%$ ), the resistance range  $1\Omega \sim 500M\Omega$ , and the rated power 0.8W ~ 6W to choose from.

Token (HI80) Voltage Resistor series is able to absorb large amounts of energy at high voltage while remaining non-inductive and heavy load characteristics. The HI80 conforms to the RoHS directives and Lead-free. Customized design, and tighter tolerances are available on request. For customized designs, tighter tolerances, non-standard technical requirements, or custom special applications, please contact our sales for more information or link to Token official website "[High Voltage Resistors](http://www.token.com.tw)" to get more information.



## ► HI80D Spec.

### Conventional High Voltage Resistor Construction (HI80D)

	Membrane Material (a)	Ruthenium Paste
	Base Material (b)	95% Aluminum Oxide, Al <sub>2</sub> O <sub>3</sub>
	Encapsulating Material (c)	High Temperature Silicone Resin

### Specifications & Painted Dimensions (Unit: mm) (HI80D)

Part Number	Rated power (W) Ambient temperature (75°C)	Max. continuous Oper. Volt (KV)	Resistance range (Ω)		Dimensions (mm)			
			Min.	Max.	L ±0.5mm	E ±3mm	D ±0.5mm	d ±0.1mm
HI80D-15	0.5	3.0	200	1G	15	30	5.0	0.8
HI80D-20	2.5	4.8	200	1G	20	28	8.0	1.0
HI80D-26	3.7	6.4	250	1G	27	28	8.0	1.0
HI80D-32	4.5	8.0	300	1.5G	33	28	8.0	1.0
HI80D-39	5.2	12.8	400	1.5G	39	28	8.0	1.0
HI80D-52	7.5	16	500	2.5G	52	28	8.0	1.0
HI80D-78	11	24	900	4G	78	28	8.0	1.0
HI80D-103	12	32	1K2	6G	103	28	8.0	1.0
HI80D-124	15	40	1K5	8G	124	28	8.0	1.0
HI80D-154	20	45	2K	10G	154	28	8.0	1.0



Conventional High Voltage Resistor Painted Dimensions (Unit: mm) - (HI80D)

## ► HI80DS Spec.

### Conventional Miniature High Voltage Resistor Construction (HI80DS)

	Membrane Material (a)	Ruthenium Paste
	Base Material (b)	95% Aluminum Oxide, $Al_2O_3$
	Encapsulating Material (c)	High Temperature Silicone Resin

### Conventional Miniature Specifications & Painted Dimensions (Unit: mm) (HI80DS)

Part Number	Rated power (W) Ambient temperature (75°C)	Max. continuous Oper. Volt (KV)	Resistance range ( $\Omega$ )		Dimensions (mm)			
			Min.	Max.	L $\pm 0.5$ mm	E $\pm 3$ mm	D $\pm 0.5$ mm	d $\pm 0.1$ mm
HI80DS-20	3	4.8	200	1G	20.2	30	8.2	1.0
HI80DS-26	5	6.4	250	1G	26.9	30	8.2	1.0
HI80DS-32	7	8.0	300	1.5G	33.0	30	8.2	1.0
HI80DS-39	9	12.8	400	1.5G	39.5	30	8.2	1.0
HI80DS-52	10	16	500	2.5G	52.1	30	8.2	1.0
HI80DS-78	15	24	900	4G	77.7	30	8.2	1.0
HI80DS-103	20	32	1K2	6G	102.9	30	8.2	1.0
HI80DS-124	25	40	1K5	8G	123.7	30	8.2	1.0
HI80DS-154	30	45	2K	10G	153.7	30	8.2	1.0



Conventional Miniature Specifications & Painted Dimensions (Unit: mm) - (HI80DS)



## ► HI80T Spec.

### Conventional High Voltage Resistor Construction (HI80D)

	Membrane Material (a)	Ruthenium Paste
	Base Material (b)	95% Aluminum Oxide, Al <sub>2</sub> O <sub>3</sub>
	Encapsulating Material (c)	High Temperature Silicone Resin

### Ultra-Precision High Voltage Resistor Specifications (HI80T)

Part Number	Rated power (W)	Max. continuous Oper. Volt (KV)	Resistance range (Ω)	L ±0.5mm	E ±3mm	D ±0.5mm	d ±0.1mm
HI80T-20	0.8	3	1 ~ 500M	20	30	8	1
HI80T-26	1.0	4	1 ~ 500M	27	30	8	1
HI80T-32	1.2	5	1 ~ 500M	33	30	8	1
HI80T-39	1.5	6	1 ~ 500M	39	30	8	1
HI80T-52	2	10	1 ~ 500M	52	30	8	1
HI80T-78	3	15	1 ~ 500M	78	30	8	1
HI80T-103	4	20	1 ~ 500M	103	30	8	1
HI80T-124	5	25	1 ~ 500M	124	30	8	1
HI80T-154	6	30	1 ~ 500M	154	30	8	1



Ultra-Precision High Voltage Resistor Unpainted Dimensions (Unit: mm) - (HI80T)

## HI80P Specifications

### High-Power High Voltage Resistor Construction (Unit: mm) (HI80P)

	Membrane Material (a)	Ruthenium Paste
	Base Material (b)	95% Aluminum Oxide, Al <sub>2</sub> O <sub>3</sub>
	Encapsulating Material (c)	High Temperature Silicone Resin
	Cap (d)	Nickel Plating Copper

### High-Power High Voltage Resistor Specifications (Unit: mm) (HI80P)

Part Number	Rated power (W)	Max. continuous Oper. Volt (KV)	Resistance range (Ω)	L ±1mm	E ±1mm	D ±0.5mm	d ±0.01mm
HI80P-20	20	30	1 ~ 1G	116	10	17	M6
HI80P-30	30	30	1 ~ 1G	116	10	19	M6
HI80P-50	50	30	1 ~ 1G	116	10	21	M6
HI80P-80	80	30	1 ~ 1G	130	10	28	M6
HI80P-100	100	35	1 ~ 1G	160	10	28	M6
HI80P-150	150	60	1 ~ 1G	210	10	28	M6
HI80P-200	200	60	1 ~ 1G	260	10	28	M6
HI80P-300	300	80	1 ~ 1G	310	10	33	M6

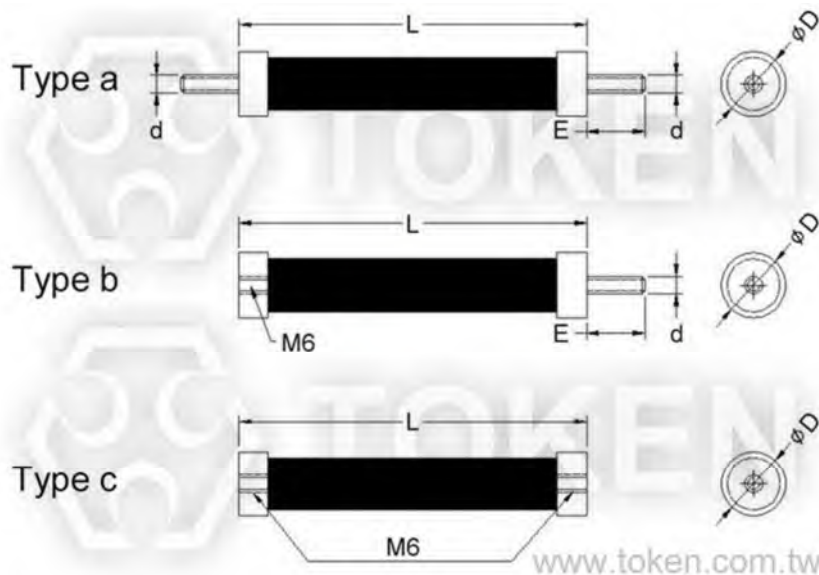

High-Power High Voltage Resistor Dimensions (Unit: mm) - (HI80P)

## ► Environmental Characteristics

### Technical Characteristics - (HI80)

Part Number	Resistance range ( $\Omega$ )	Tolerance (%)	TCR @25°C (-55°C ~ +105°C)	Insulation withstand voltage	Insulation resistance	Operating temp. range
HI80D	200 ~ 10G	$\pm 1\% \sim \pm 10\%$	$\pm 100\text{ppm}/^\circ\text{C}$ , ( $\pm 50\text{ppm}/^\circ\text{C}$ on request)	1000VDC	$\geq 10\text{G}\Omega$	-55°C ~ +225°C
HI80DS	200 ~ 10G	$\pm 5\% \sim \pm 10\%$	$\pm 100\text{ppm}/^\circ\text{C}$ , ( $\pm 50\text{ppm}/^\circ\text{C}$ on request)			
HI80T	1 ~ 500M	$\pm 0.1\% \sim \pm 1\%$	$\pm 25\text{ppm}/^\circ\text{C}$ , ( $\pm 15\text{ppm}/^\circ\text{C}$ on request)			
HI80P	1 ~ 1G	$\pm 0.5\% \sim \pm 10\%$	$\pm 50\text{ppm}/^\circ\text{C}$ , ( $\pm 25\text{ppm}/^\circ\text{C}$ on request)			

### Environmental Characteristics - (HI80)

Inspection item	Inspection method	Performance requirement
Overload	5 times the rated power, but not more than 1.5 times the maximum continuous operating voltage, 5 seconds	$\Delta R \leq \pm(0.2\%R + 0.01\Omega)$
Load life	1000 hours under rated power	$\Delta R \leq \pm(0.5\%R + 0.01\Omega)$
Steady-state damp heat	40°C, RH $\geq$ 95%, 240h	$\Delta R \leq \pm(0.4\%R + 0.01\Omega)$
Temperature shock	-65°C ~ 155°C, 5 cycle	$\Delta R \leq \pm(0.2\%R + 0.01\Omega)$



## ▶ Power Derating Curve

### Power Derating Curve - (HI80)

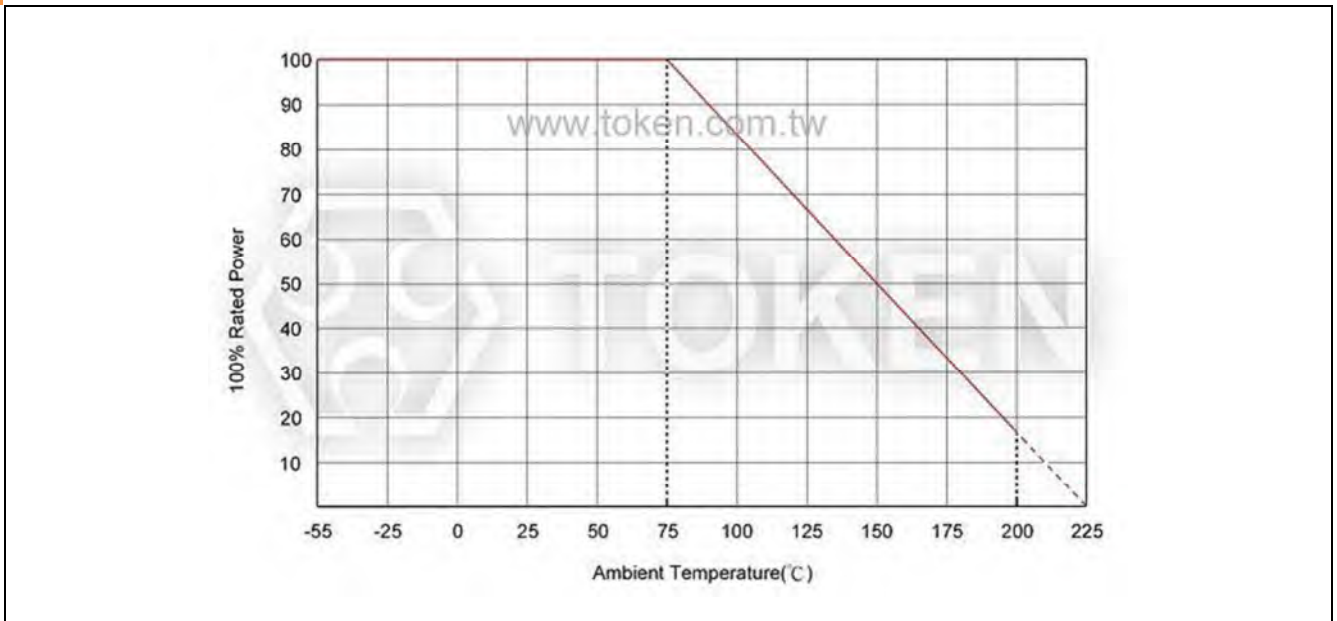

### Power Derating Curve - (HI80DS)

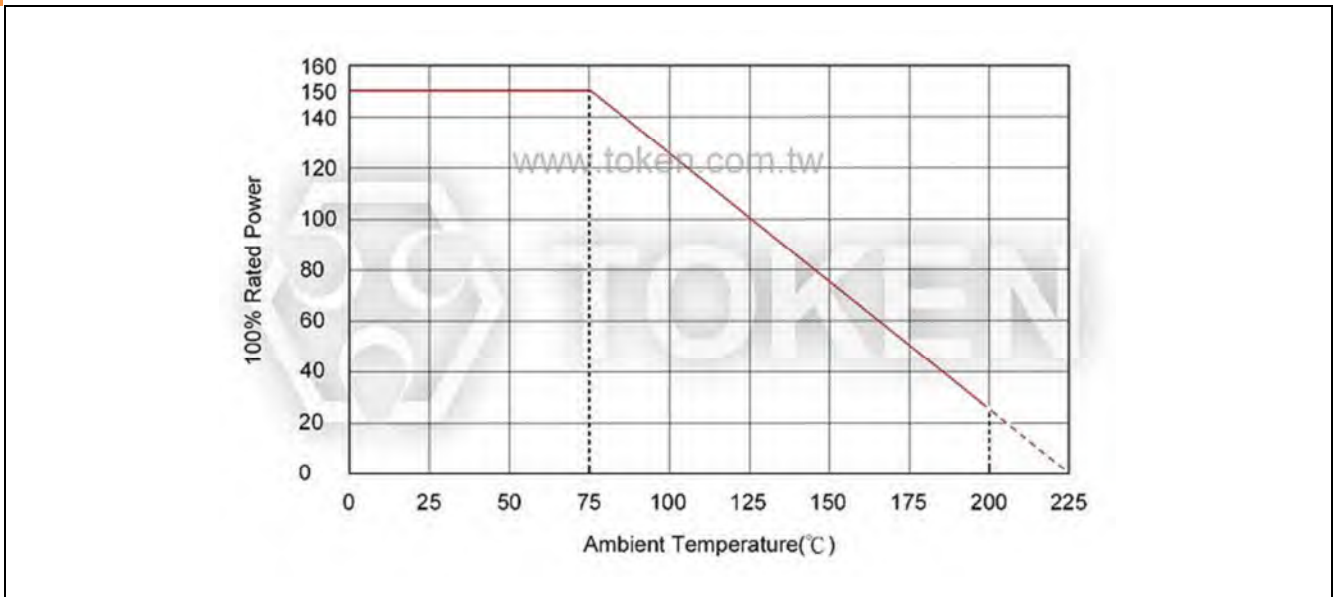

## ► Serpentine Pattern

### Advance Technique of Non-Inductive & Serpentine Pattern (HI80)

#### Non-Inductive Performance:

- HI80 Non-Inductive Design which uses a serpentine resistive pattern that offers for zigzagging lines to carry current in opposite directions, thereby achieving maximum neutralization of flux fields over the entire length of the resistor.
- This efficient non-inductive construction without derating of any performance advantages is ideal for applications where high frequency is required.



#### Serpentine Pattern Screen Printing Design:

- Type High Voltage HI80 Precision Resistors combine Token's Non-Inductive serpentine pattern, high thru-put screen printed silicone coating.
- The alignment of the gap in the serpentine resistor pattern with the gap in the coating pattern provides a complete encapsulation of the resistor element.
- The cap and lead assemblies are pressed onto the resistor core, finishing the resistor and providing rugged terminal attachment.



## Order Codes

### Order Codes (HI80D) Conventional High Voltage Resistor

HI80D	39		1G		F	
Part Number	Rated Power (W)		Resistance Value ( $\Omega$ )		Resistance Tolerance (%)	
HI80D	20	2.5W	1K1	1.1K $\Omega$	F	$\pm 1\%$
	26	3.7W	110K	110K $\Omega$	J	$\pm 5\%$
	39	5.2W	1M1	1.1M $\Omega$	K	$\pm 10\%$
	103	12W	110M	110M $\Omega$		
	154	20W	1G5	1.5G $\Omega$		
			10G	10G $\Omega$		

- Note: TCR 100ppm/ $^{\circ}\text{C}$ , ( $\pm 50\text{ppm}/^{\circ}\text{C}$  on request).

### Order Codes (HI80DS) Conventional Miniature high voltage resistors

HI80DS	124		1G		F	
Part Number	Rated Power (W)		Resistance Value ( $\Omega$ )		Resistance Tolerance (%)	
HI80DS	20	3W	1K1	1.1K $\Omega$	J	$\pm 5\%$
	32	7W	110K	110K $\Omega$	K	$\pm 10\%$
	78	15W	1M1	1.1M $\Omega$		
	103	20W	110M	110M $\Omega$		
	154	30W	1G5	1.5G $\Omega$		
			10G	10G $\Omega$		

- Note: TCR 100ppm/ $^{\circ}\text{C}$ , ( $\pm 50\text{ppm}/^{\circ}\text{C}$  on request).

### Order Codes (HI80T) Ultra-Precision High Voltage Resistor

HI80T	32		500M		B	
Part Number	Rated Power (W)		Resistance Value ( $\Omega$ )		Resistance Tolerance (%)	
HI80T	20	0.8W	10	10 $\Omega$	B	$\pm 0.1\%$
	32	1.2W	1K1	1.1K $\Omega$	D	$\pm 0.5\%$
	52	2W	110K	110K $\Omega$	F	$\pm 1\%$
	154	6W	1M1	1.1M $\Omega$		
			500M	500M $\Omega$		

- Note: TCR  $\pm 25\text{ppm}/^{\circ}\text{C}$ , ( $\pm 15\text{ppm}/^{\circ}\text{C}$  on request).

## Order Codes (HI80P) High-Power High Voltage Resistor

HI80P	20		a	1G		F	
Part Number	Rated Power (W)		Type	Resistance Value ( $\Omega$ )		Resistance Tolerance (%)	
HI80P	20	20W	a	10	10 $\Omega$	D	$\pm 0.5\%$
	30	30W	b	1K1	1.1K $\Omega$	F	$\pm 1\%$
	150	150W	c	110K	110K $\Omega$	J	$\pm 5\%$
	300	300W		1M1	1.1M $\Omega$	K	$\pm 10\%$
				110M	110M $\Omega$		
				10G	10G $\Omega$		

- Note: TCR  $\pm 50\text{ppm}/^\circ\text{C}$ , ( $\pm 25\text{ppm}/^\circ\text{C}$  on request).



# Ultra-Precision High Voltage Film Resistors (HI82)

## ▶ Product Introduction

Up to 10TΩ, (HI82) sets a new standard for high value, ultra-stable precision high voltage resistors.

### (HI82) Family Members:

- (HI82D) Precision High-Voltage High-Value Resistor series, resistance range from 1mΩ to 10TΩ, precision tolerance from 30% to 0.25%, rated power has 1w/1.2w/3w selectable.
- (HI82H) Conventional Precision High-Voltage High Resistance Resistor series, various precision tolerance 1%/2%/5%/10%/20%/30%/50% available, four kinds of rated power 0.5w/0.7/1w/2w selectable, resistance from 1MΩ to 1TΩ.
- (HI82T) High Power Voltage Resistor series, maximum operating voltage up to 35KV, 30W high rated power to 0.125W, resistance range from 1Ω to 500MΩ, tolerance range 0.5% to 5%.

### Features :

- High voltage thick film precision technology resistor.
- Resistance up to 10TΩ. Low TCR, low VCR.
- Radial leads, variable lead spacing by bending.
- Climatic protection by silicone coating

### Applications :

- Impulse voltage generators,
- Arc furnace damping, Energy research,
- Pulse modulators, Radar Pulse-forming networks,
- Capacitor crowbar circuits, High voltage snubber circuits,

The high performance high-voltage applications require the use of high voltage resistors in applications with long-term stability and good temperature coefficient. Token Electronics has introduced ultra-stable high-precision HI82 high voltage resistors to meet these needs.

Token's unique precision full film and serpentine transfer pattern (serpentine patterns design), using a specific high speed fine-line thick film dispensing system, developed a series of high voltage application resistor components with excellent performance. Especially in smaller sizes and higher resistance-value components.

Through the use of alloy ruthenium paste material, and 95% high aluminum planar ceramic chip, Token can control the manufacture of very precise precision and stabilize the performance parameters of important high-voltage operating temperature range. (HI82) thick film resistor combined with close tracking design, with low current noise, linear current voltage, low TCR, high temperature durability, wide resistance range, long-term stability, and low-cost advantages.

Token HI82 ultra-precision high-voltage resistors conform with RoHS and lead-free standards and provide more competitive prices and fast delivery service. For technical specifications and special applications, please contact your Token's sales representative, or link to Token official website "[High Voltage Resistors](http://www.token.com.tw)" to get more information.



## ► Dimensions

### Composition Structure (HI82)

	<b>Membrane Material (a)</b>	Ruthenium Paste
	<b>Base Material (b)</b>	95% Aluminum Oxide, Al <sub>2</sub> O <sub>3</sub>
	<b>Encapsulating Material (c)</b>	High Temperature Silicone Resin

## Ultra-precision high value voltage Resistor Dimensions (Unit: mm)

HI82D Ultra-precision high-voltage high-value resistor						
Part Number	L ±1mm	H ±1mm	T ±0.5mm	P ±2mm	I ±3mm	d ±0.1mm
HI82D-1W	30.0	6.0	1.4	27.5	20	0.4
HI82D-1BW	40.0	6.0	1.4	37.8	20	0.4
HI82D-3W	50.0	12.5	1.4	47.8	20	0.4

Note: L = Length, H = Width, T = Thickness, I = Length of steel wire, d = Wire diameter °  
P = Standard lead spacing ( Other spacing possible by bending ) °

HI82H Conventional precision high-voltage high-resistance resistor						
Part Number	L ±1mm	H ±1mm	T ±0.5mm	P ±2mm	I ±3mm	d ±0.1mm
HI82H-05W	3.2	2.5	0.9	2.0	20	0.4
HI82H-07W	3.8	5.0	1.0	2.5	20	0.4
HI82H-1W	6.3	3.5	1.0	5.5	20	0.4
HI82H-2W	10.2	5.1	1.0	9.5	20	0.4

Note: L = Length, H = Width, T = Thickness, I = Length of steel wire, d = Wire diameter °  
P = Standard lead spacing ( Other spacing possible by bending ) °

HI82T High-power voltage resistor						
Part Number	L ± 1mm	H ± 1mm	T ± 0.5mm	P ± 2mm	I ± 3mm	d ± 0.1mm
HI82T-0125W	8	3.5	2	5.7	10	0.6
HI82T-025W	10	5	2	7.7	10	0.6
HI82T-04W	25	5	2	22.5	20	0.6
HI82T-05W	35	5	2	32	20	0.6
HI82T-1W	30	8	2	27	20	0.6
HI82T-2SW	25	10	2	22	20	0.6
HI82T-2NW	22	18	2	19	20	0.6
HI82T-2BW	45	10	3	41.5	20	0.8
HI82T-3W	60	10	3	56.5	20	0.8
HI82T-5W	80	20	4	76.5	40	1.0
HI82T-10W	97	23	4	93.5	40	1.0
HI82T-20W	100	35	4	96.5	40	1.0
HI82T-30W	100	48	4	96.5	40	1.0

Note: L = Length, H = Width, T = Thickness, I = Length of steel wire, d = Wire diameter °  
P = Standard lead spacing ( Other spacing possible by bending ) °

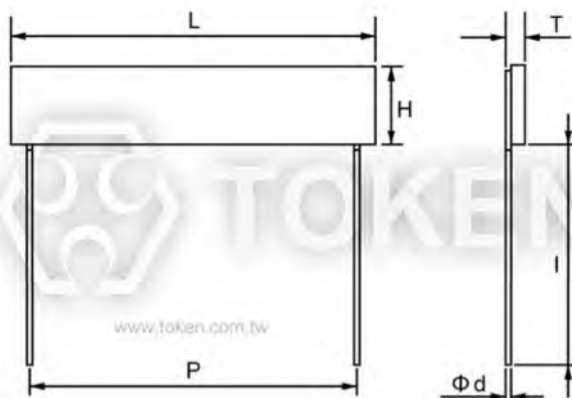

Ultra-precision high value voltage Resistor Dimensions (Unit: mm)



## ► HI82D Electrical Charcs.

### Technical Characteristics - (HI82D)

Part Number	Power Rating P <sub>70</sub> (W)	Working Voltage Max. (V)	Resistance Range (Ω)	Tolerance (%)	TCR <sup>(1)</sup> (ppm/ °C)	VCR <sup>(2)</sup> (ppm/V)
HI82D-1W	1.0	10KV	1M - 100M	0.25/0.5/5/10	25/50/100	2ppm/V
			100M - 1G	1/2/5/10/20	50/100/250	5ppm/V
			1G - 100G	5/10/20/30	250/500	20ppm/V
			100G - 1T	5/10/20/30	500/1000	100ppm/V
HI82D-1BW	1.2	20KV	1M - 100M	0.25/0.5/5/10	25/50/100	1ppm/V
			100M - 1G	1/2/5/10/20	50/100/250	2ppm/V
			1G - 100G	5/10/20/30	250/500	10ppm/V
			100G - 1T	5/10/20/30	500/1000	50ppm/V
HI82D-3W	3.0	30KV	1M - 100M	0.25/0.5/5/10	25/50/100	1ppm/V
			100M - 1G	1/2/5/10/20	25/50/100	1ppm/V
			1G - 100G	5/10/20/30	100/250	5ppm/V
			100G - 1T	5/10/20/30	250/500	25ppm/V
			1T - 10T	10/20/30	500/1000	100ppm/V

**Note:**

- <sup>(1)</sup> TCR 25/50: Temperature range +25°C ~ +85°C ; <sup>(2)</sup> The voltage coefficient is measured between 10V and 100V.
- Operating Voltage =  $\sqrt{(P * R)}$  , or Max. Operating Voltage listed in above table whichever is lower.
- Optional specifications on request.

### Environmental Characteristic

Continuous operating voltage	V = $\sqrt{(P * R)}$ , or Max. Operating Voltage listed in above table whichever is lower.	
Measuring voltage	Standard measuring voltage is 10V (50V for values >1G). Different voltages on request.	
TCR ppm/°C	Temperature range +25°C ~ +125°C	
	TCR25/50	
	Values above 1G: +25°C ~ +85°C.	
Operating temp. range	-55°C ~ +125°C	
Climatic category to EN 60068-1	55/125/56	
Humidity-/contact protection	Lacquer coating. Resistant to most solvents. Isopropyl alcohol recommended for cleaning; Do not use acetone or methylene chloride. Avoid mechanical stress to coating.	
Stability: Storage 125°C/1000Hrs	≤10G	>10G
	<1%	<2%
Stability at Max. voltage/1000Hrs	≤10G	>10G
	<1%	<2%

## ► HI82H Electrical Characs.

### Technical Characteristics - (HI82H)

Part Number	Power Rating P <sub>70</sub> (W)	Working Voltage Max. (V)		Resistance Range (Ω)	Tolerance (%)	TCR <sup>(1)</sup> (ppm/°C)	VCR <sup>(2)</sup> (ppm/V)
		trimmed	untrimmed				
HI82H-05W	0.5	300	1000	1M - 100M	1/2/5/10	TC25/50/100	<50ppm/V
				>100M - 500M	2/5/10/20	TC50/100/250	<100ppm/V
				>500M - 1G	5/10/20	TC100/250	<100ppm/V
				>1G - 10G	5/10/20/30	TC250/500	<500ppm/V
				>10G - 100G	5/10/20/30	TC500/1000	<1000ppm/V
				>100G - 1T	-	-	-
HI82H-07W	0.7	300	500	1M - 100M	2/5/10	TC50/100	<50ppm/V
				>100M - 500M	5/10/20	TC100/250	<100ppm/V
				>500M - 1G	5/10/20	TC100/250	<100ppm/V
				>1G - 10G	10/20/30	TC250/500	<500ppm/V
				>10G - 100G	10/20/30	TC500/1000	<1000ppm/V
				>100G - 1T	-	-	-
HI82H-1W	1.0	1200	2500	1M - 100M	1/.../10	TC25/50/100	<10ppm/V
				>100M - 500M	1/2/5/10/20	TC25/50/100	<25ppm/V
				>500M - 1G	1/2/5/10/20	TC100/250	<25ppm/V
				>1G - 10G	2/5/10/20	TC100/250	<100ppm/V
				>10G - 100G	5/10/20/30	TC250/500	<250ppm/V
				>100G - 1T	10/20/30/50	TC500/1000	<500ppm/V
HI82H-2W	2.0	4000	6000	1M - 100M	1/.../10	TC25/50/100	<5ppm/V
				>100M - 500M	1/2/5/10/20	TC25/50/100	<10ppm/V
				>500M - 1G	1/2/5/10/20	TC25/50/100	<10ppm/V
				>1G - 10G	2/5/10/20	TC50/100	<25ppm/V
				>10G - 100G	5/10/20/30	TC100/250	<100ppm/V
				>100G - 1T	5/10/20/30	TC250/500	<250ppm/V

**Note:**

- <sup>(1)</sup> TCR 25/50: Temperature range +25°C ~ +85°C ; <sup>(2)</sup> The voltage coefficient is measured between 10V and 100V.
- Operating Voltage =  $\sqrt{(P * R)}$  , or Max. Operating Voltage listed in above table whichever is lower.
- Optional specifications on request.

### Environmental Characteristic

Continuous Operating Voltage	V = $\sqrt{(P * R)}$ , or Max. Operating Voltage listed in above table whichever is lower.		
Measuring Voltage	Standard measuring voltage is 10V (50V for values >1G). Different voltages on request.		
TCR ppm/°C	Temperature range +25°C ~ +125°C		
	TCR25/50		
	Values above 1G: +25°C ~ +85°C.		
Operating Temperature Range	-55°C ~ +125°C		
Climatic Category to EN 60068-1	55/125/56		
Humidity-/Contact Protection	Lacquer coating. Resistant to most solvents. Isopropyl alcohol recommended for cleaning; Do not use acetone or methylene chloride. Avoid mechanical stress to coating.		
Stability: Storage 125°C/1000Hrs.	≤1G	≤10G	>10G
	<1%	<2%	<5%
	≤1G	≤10G	>10G
Stability at Max. voltage/1000Hrs.	≤1G	≤10G	>10G
	<0.5%	<1%	<2%



## ► HI82T Electrical Charcs.

### Technical Characteristics - (HI82T)

Part Number	Power Rating P <sub>75</sub> (W)	Working Voltage Max. (V)	Resistance Range (Ω)	Tolerance (%)	TCR
HI82T-0125W	1/8W	2KV	1 ~ 500M	±0.5% ~ ±5%	±100ppm/°C
HI82T-025W	1/4W	4KV	1 ~ 500M		
HI82T-04W	2/5W	10KV	1 ~ 500M		
HI82T-05W	1/2W	15KV	1 ~ 500M		
HI82T-1W	1W	15KV	1 ~ 500M		
HI82T-2SW	2W	20KV	1 ~ 500M		
HI82T-2NW	2W	20KV	1 ~ 500M		
HI82T-2BW	2W	20KV	1 ~ 500M		
HI82T-3W	3W	25KV	1 ~ 500M		
HI82T-5W	5W	30KV	1 ~ 500M		
HI82T-10W	10W	35KV	1 ~ 500M		
HI82T-20W	20W	35KV	1 ~ 500M		
HI82T-30W	30W	35KV	1 ~ 500M		

**Note :**

- TCR @25°C (25°C ~ +105°C). TCR ±15ppm/°C on request.
- Operating Voltage =  $\sqrt{(P * R)}$  , or Max. Operating Voltage listed in above table whichever is lower.
- Optional specifications on request.

### Environmental Characteristic

Continuous Operating Voltage	V = $\sqrt{(P * R)}$ , or Max. Operating Voltage listed in above table whichever is lower.		
Measuring Voltage	Standard measuring voltage is 10V (50V for values >1G). Different voltages on request.		
TCR ppm/°C	Temperature range +25°C ~+105°C		
	TCR 25/50 Values above 1G: +25°C ~+105°C .		
Operating Temperature Range	-55°C ~ +225°C		
Climatic Category to EN 60068-1	55/125/56		
Insulation withstand voltage	1000VDC		
Insulation resistance	≥ 10GΩ		
Humidity-/Contact Protection	Lacquer coating. Resistant to most solvents. Isopropyl alcohol recommended for cleaning; Do not use acetone or methylene chlorid. Avoid mechanical stress to coating.		
Stability: Storage 125°C/1000Hrs.	≤1G	≤10G	>10G
	<1%	<2%	<5%
Stability at Max. voltage/1000Hrs.	≤1G	≤10G	>10G
	<0.5%	<1%	<2%

## ▶ Power Derating Curve

### Power Derating Curve - (HI82D & HI82H)

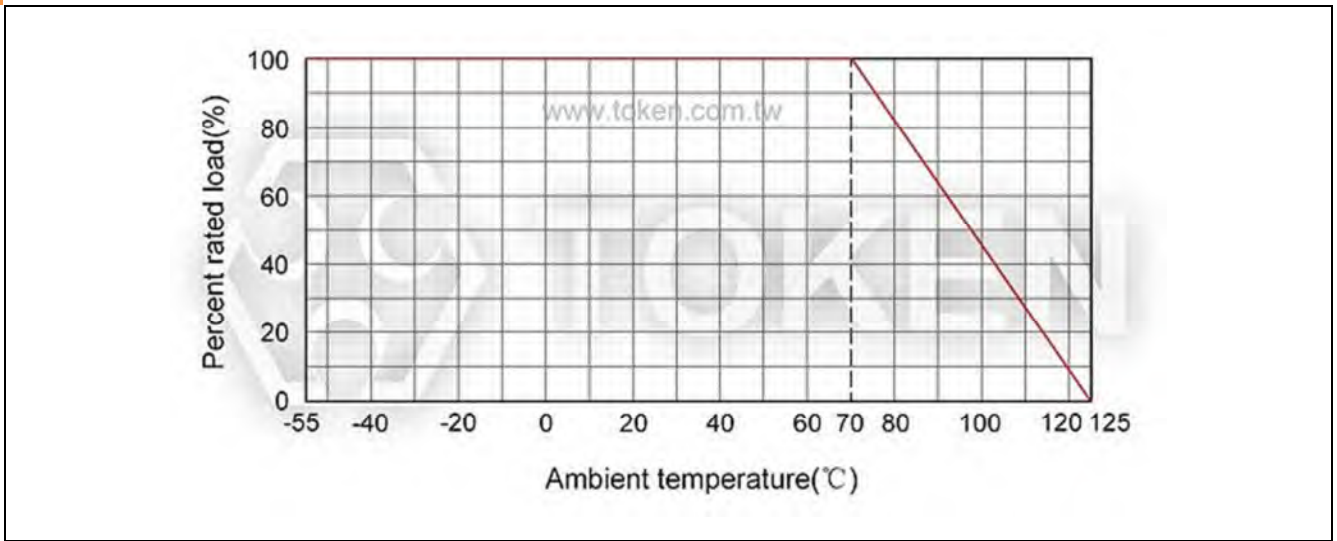

### Power Derating Curve - (HI82T)

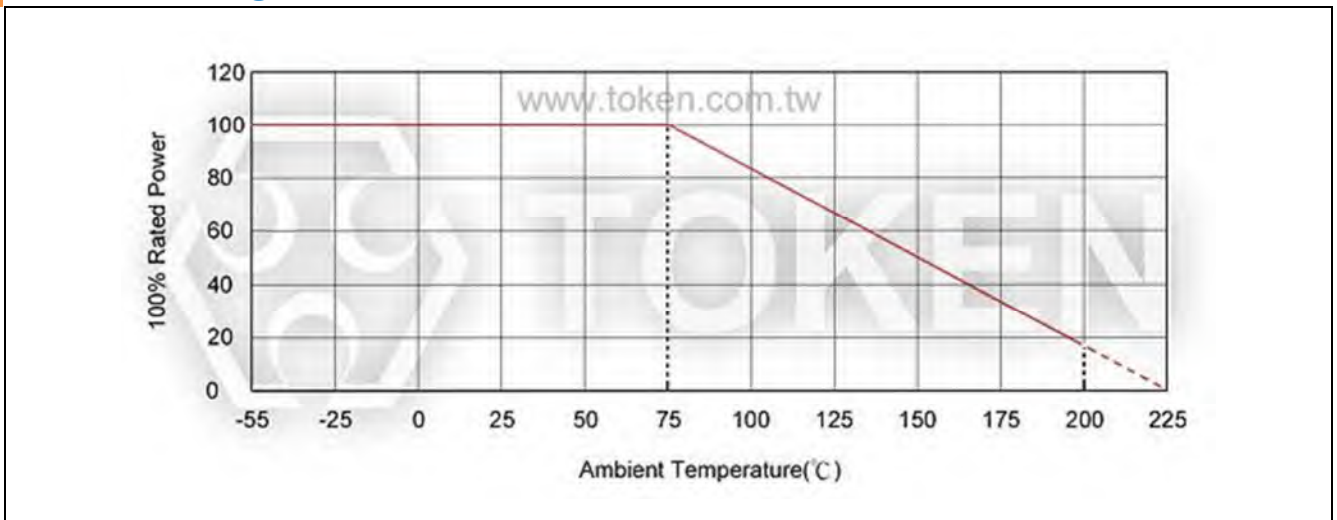

### ▶ Advance Technique

#### Advance Technique of Non-Inductive & Serpentine Pattern (HI82)

##### Non-Inductive Performance:

- HI82 Non-Inductive Design which uses a serpentine resistive pattern that offers for zigzagging lines to carry current in opposite directions, thereby achieving maximum neutralization of flux fields over the entire length of the resistor.
- This efficient non-inductive construction without derating of any performance advantages is ideal for applications where high frequency is required.



##### Serpentine Pattern Screen Printing Design:

- Type High Voltage HI82 Precision Resistors combine Token's Non-Inductive serpentine pattern, high thru-put screen printed silicone coating.
- The alignment of the gap in the serpentine resistor pattern with the gap in the coating pattern provides a complete encapsulation of the resistor element.
- The cap and lead assemblies are pressed onto the resistor core, finishing the resistor and providing rugged terminal attachment.



## Order Codes

### Order Codes (HI82D) - Ultra-Precision High-Voltage High Value Resistors

HI82D	1W		1G		F		E	
Part Number	Rated Power (W)		Resistance Value ( $\Omega$ )		Resistance Tolerance (%)		TCR (ppm/ $^{\circ}$ C)	
HI82D	1W	1.0W	1M1	1.1M $\Omega$	C	$\pm 0.25\%$	C	$\pm 25$ ppm/ $^{\circ}$ C
	1BW	1.2W	110M	110M $\Omega$	D	$\pm 0.5\%$	D	$\pm 50$ ppm/ $^{\circ}$ C
	3W	3.0W	1G5	1.5G $\Omega$	F	$\pm 1\%$	E	$\pm 100$ ppm/ $^{\circ}$ C
			10G	10G $\Omega$	J	$\pm 5\%$	L	$\pm 250$ ppm/ $^{\circ}$ C
					K	$\pm 10\%$	I	$\pm 500$ ppm/ $^{\circ}$ C
					M	$\pm 20\%$	R	$\pm 1000$ ppm/ $^{\circ}$ C
					N	$\pm 30\%$		

### Order Codes (HI82H) - Conventional Precision High-Voltage High-Resistance Resistors

HI82H	2W		1G		F		E	
Part Number	Rated Power (W)		Resistance Value ( $\Omega$ )		Resistance Tolerance (%)		TCR (ppm/ $^{\circ}$ C)	
HI82H	05W	0.5W	1M1	1.1M $\Omega$	F	$\pm 1\%$	C	$\pm 25$ ppm/ $^{\circ}$ C
	07W	0.7W	110M	110M $\Omega$	G	$\pm 2\%$	D	$\pm 50$ ppm/ $^{\circ}$ C
	1W	1.0W	1G5	1.5G $\Omega$	J	$\pm 5\%$	E	$\pm 100$ ppm/ $^{\circ}$ C
	2W	2.0W	10G	10G $\Omega$	K	$\pm 10\%$	L	$\pm 250$ ppm/ $^{\circ}$ C
			1T	1T $\Omega$	M	$\pm 20\%$	I	$\pm 500$ ppm/ $^{\circ}$ C
					N	$\pm 30\%$	R	$\pm 1000$ ppm/ $^{\circ}$ C

### Order Codes (HI82T) - High-Power Voltage Resistors

HI82T	30W		500M		F		E	
Part Number	Rated Power (W)		Resistance Value ( $\Omega$ )		Resistance Tolerance (%)		TCR (ppm/ $^{\circ}$ C)	
HI82T	0125W	1/8W	10	10 $\Omega$	D	$\pm 0.5\%$	E	$\pm 100$ ppm/ $^{\circ}$ C
	04W	2/5W	1M1	1.1M $\Omega$	F	$\pm 1\%$	C5	$\pm 15$ ppm/ $^{\circ}$ C on request
	2BW	2W	110M	110M $\Omega$	J	$\pm 5\%$		
	10W	10W	500M	500M $\Omega$				
	30W	30W						

- Note: If no requirements for TCR, (HI82D), (HI82H) and (HI82T) measuring voltage and taping are given, the standard value(highest value in table) will be supplied, measuring voltage of 10V.

# Carbon Composition Resistors (CCR)

## ▶ Product Introduction

**High pulse withstanding carbon composition resistors handle big peaks and pulses.**

### Features :

- Low inductance
- Solid rod carbon composition
- Power rating 1/4W and 2W
- Resistance range 1.8Ω ~ 22KΩ
- Resistance tolerance J(±5%), K(±10%) and M(±20%)
- High pulse withstanding and high energy capability
- Products with Pb-free Terminations and RoHS compliant

### Applications :

- Strobe Lighting
- High Power Lighting
- Medical defibrillators
- Welding, Automotive
- Inrush Current Limiting
- High Voltage Power Supplies
- Protection (e.g. Discharge Circuits, Surge Protection)

The high pulse withstanding capability of the CCR series of carbon composition resistors from Token Electronics offers designers a compact solution for applications involving high voltages and high-energy pulses.

Though, many resistor manufacturers claim to offer carbon composition replacements. However, these wire wound or thick film alternatives do not fully match the pulse performance and low inductance of carbon composition.

Token's CCR series now offers the industry a carbon composition resistor made up of a solid rod of conductive composite material, the chemical composition of which is altered to produce different resistance values.

The main advantage of carbon composition is their pulse handling capability. This is due to the fact that the entire rod conducts and so the thermal mass is far higher, which results in a higher energy capability. Due to the need for higher peak voltages, the CCR range is perfect for vehicle ignition system applications, medical monitoring equipment and as output resistors in defibrillators.

The standard carbon composition CCR resistor offers a power rating of 1/4W, 1/2W, 1W and 2W at 25 °C and is made up of a solid rod of conductive composition material, which can be altered to produce different resistance values. With a typical resistance range of 1.8Ω ~ 22KΩ, resistance tolerance is J(±5%), K(±10%) and M(±20%). Resistors with 5%, 10% and 20% tolerance have four bands indicating value and tolerance in accordance with IEC62.

Our custom solutions are designed to address your need for technical and economic success in a timely manner. Contact us with your specific needs. For more information, please link to Token official website "[High Voltage Resistors](http://www.token.com.tw)".



## ► Dimensions

### Dimensions (Unit: mm) (CCR)

Type	Power Rating	L	Φ D	H	Φ d
CCR	1/4W	6.3	2.3±0.3	27±2	0.60±0.02
CCR	1/2W	9.5	3.5±0.3	27±2	0.70±0.02
CCR	1W	15	6.0±0.3	28±2	0.80±0.02
CCR	2W	18	8.0±0.3	27±2	1.00±0.02

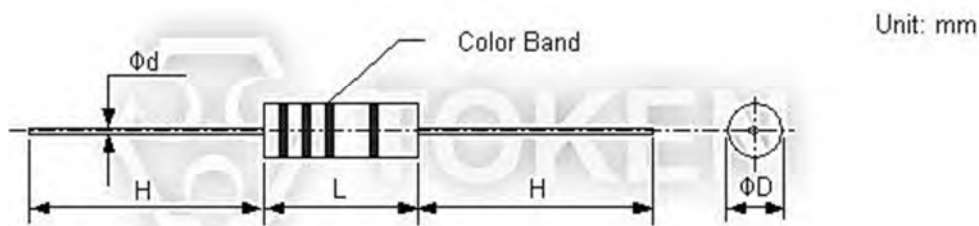

Carbon Composition (CCR) Dimensions (Unit: mm)

## ► Ratings Specifications

### Ratings Specifications (CCR)

Type	Power Rating	Resistance Range	Tolerance E12,E24	Max Working voltage	Max overload Voltage	Rated Ambient Temp.	Operating Temp. Range
CCR	1/4W	2.2Ω ~ 12MΩ	J(±5%) K±10% M±20%	250V	400V	+70°C	-55°C ~ +125°C
CCR	1/2W	2.2Ω ~ 22MΩ		350V	700V	+70°C	-55°C ~ +125°C
CCR	1W	2.2Ω ~ 22KΩ		500V	1000V	+70°C	-55°C ~ +125°C
CCR	2W	1.8Ω ~ 10KΩ		500V	1000V	+70°C	-55°C ~ +125°C

- Rated Voltage =  $\sqrt{\text{Power Rating} * \text{Resistance Value}}$  or Max. Working voltage, whichever is lower.

### ▶ Derating Curve

#### ▮ Derating Curve (CCR)

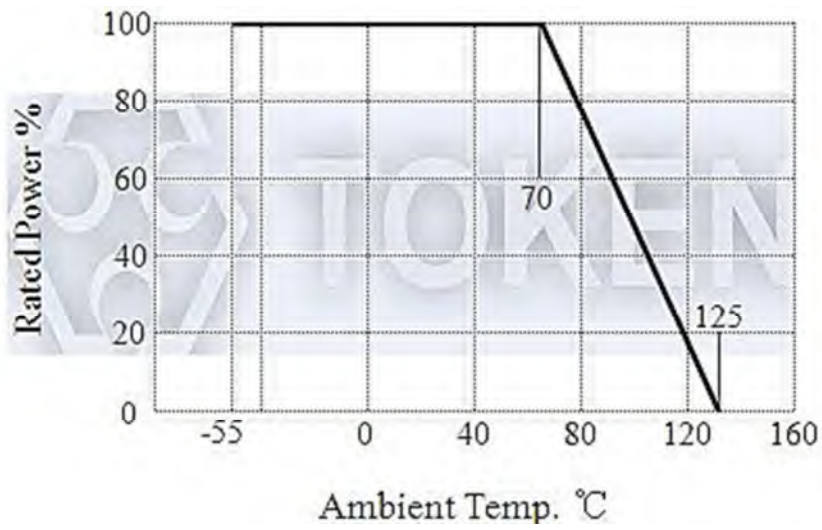

(CCR) Derating Curve

## Performance

### Performance (CCR)

Description		Performance Requirements		Test Method
Resistance Temperature Coefficient	Resistance Range	Maximum Resistance Value Change %		Test Temperature +20°C /-40°C /+20°C /+100°C /+20°C
		-40~+20°C	+20~+100°C	
	<1KΩ	±6.5%	±5.0%	
	1.1KΩ ~10KΩ	±10%	±6.0%	
	11KΩ ~100KΩ	±13%	±7.5%	
	11KΩ ~1MΩ	±15%	±10%	
	1.1MΩ ~10MΩ	±20%	±15%	
	>11MΩ	±25%	±20%	
Short-time Overload		$\Delta R \leq \pm 2.5\%$		Rate Voltage*2.5 or maximum overload voltage (the lower)5sec.
With Standing Voltage		No flashover or breakdown		2times maximum working voltage 1 minute
Terminal Strength	Pulled	$\Delta R \leq \pm 2\%$ No visible damage		Load 10N 10s
	Winded			Load 10N 4*90°
	Twisted			3*360° in opposite direction
Resistance to vibration		No visible damage		10~50Hz 3 direction 2 hours each
Solder-heat Resistance		$\Delta R \leq \pm 5\%$ Marks legible, no visible damage		350°C 4mm from the body,3 seconds
Solderability		At least 95% if the dipping surface must be covered by new solder, no flaws gathered.		235°C 2mm from the body,2 seconds
Temperature Cycle		$\Delta R \leq \pm 2\%$ No visible damage		-40°C (30min.)/85°C (30min.)5 cycles
Humidity		$\Delta R \leq \pm 10\%$ No visible damage		40°C 95% RH 240 hours
Load Life		$\Delta R \leq \pm 10\%$ No visible damage, marks legible		Rated voltage or maximum working voltage, 1.5 hours on, 0.5 hours off, 40°C 1000 hours

## Order Codes

### Order Codes (CCR)

CCR	1/2W	120R		K	P		
Part Number	Rated Power (W)	Resistance Value (Ω)		Resistance Tolerance (%)		Package	
CCR		2R2	2.2Ω	J	±5%	P	Bulk
		120R	120Ω	K	±10%		
		1M2	1.2MΩ	M	±20%		
		22M	22MΩ				



# Tubular High Voltage Precision Divider Resistors (HI80M)

## ► Product Introduction

### Cylindrical Thick Film High-Voltage Resistor Dividers Provide Accuracy And Stability.

#### Features :

- High precision, Non-Inductance design.
- High voltage, Wide range of resistance.
- Custom design services. RoHS compliant.

#### Applications :

- Pulse Modulator, Radar Pulse Forming Network, Impulse Voltage Generator.
- X-ray/Imaging Equipment, and EMI lightning suppression, Electric Arc Furnace Damping.
- Capacitor Arc Suppression Circuit, Energy Research, High Voltage Buffer Circuit.

Token Electronics is further expanding its solutions for challenging applications and introducing thick-film precision resistor dividers for high-voltage measurement circuits. The new (HI80M) was introduced to meet the growing demand in the medical, energy, industrial and instrumentation markets.

Thick film technology allows high resistance values to be printed on flat or cylindrical substrates. Not only can high resistance be obtained, but a high voltage can be applied to the thick film product with almost no change in resistance value. Many thick film resistors are printed using a serpentine pattern. This pattern helps reduce inductance and is the first choice for stable frequency applications.



As new industries expand, so does the demand for such components. Applications such as portable defibrillators, high-voltage PSUs, on-board instruments, TWT power supplies, radar systems, X-ray systems, analytical equipment, and high resolution CRT displays require components with tight tolerances, leading temperature coefficient (TCR), load life stability and extremely high impedance values to provide optimum space, weight and cost combinations. Package.

The Cylindrical (HI80M) of high quality, high voltage, versatile, non-inductive, thick film precision dividers available from Token Electronics. The (HI80M) divider features with voltage handling capability of up to 80 KVdc and has an operating temperature range of  $-55^{\circ}\text{C}$  to  $+125^{\circ}\text{C}$ , wide resistance range  $2\text{M}\Omega$  to  $1\text{G}\Omega$  with Resistive Ratio  $R_2/(R_1+R_2)$  1:1000 to 1:20000, and power up to 41W.

The (HI80M) conforms to the RoHS directives and Lead-free. To assist with your specifying high voltage divider application, please contact Token Electronics. We can offer high voltage divider combinations and solutions based on high voltage resistor sector in the catalog, or use our sophisticated features to provide higher accuracy in matching resistor sets. Customized design, and tighter tolerances are available on request. Or link to Token official website "[High Voltage Resistors](http://www.token.com.tw)" to get more information.



## Dimensions

### Cylindrical High Voltage Precision Divider Resistors (HI80M) Dimensions

Type	A±2	B±0.2	C±0.5	D±2	E±1	F±0.5	G	H±2
HI80M-156	156	14.5	13.5	10	8.5	5	M4	10
HI80M-310	310	33	32	14	40	7	M6	10

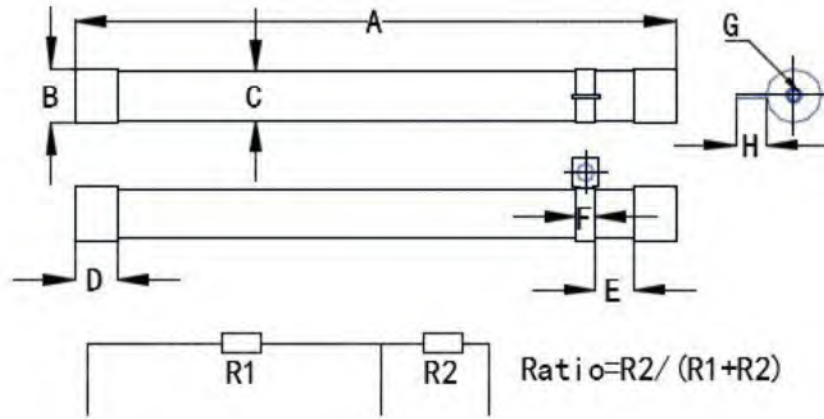

Dimensions (Unit: mm)

## Electrical Characteristics

### Electrical Characteristics - (HI80M)

Item	Specifications					
Part Number	HI80M-156			HI80M-310		
Power (W)(40°C )	12W			41W		
U Max Working Voltage (V)	40KVDC			80KVDC		
Resistance Range (R) (R1+R2)	2M~1G			5M~1G		
Absolute TCR (ppm/°C) (25°C ~85°C )	±50ppm/ ±100ppm	±25ppm	±15ppm	±50ppm/ ±100ppm	±25ppm	±15ppm
Relative TCR (ppm/°C) (25°C ~85°C )	±25ppm	±15ppm	±10ppm	±25ppm	±15ppm	±10ppm
Absolute Resistance Tolerance (%)	±0.25%~±5%	±0.25%~±5%	±0.25%~±5%	±0.25%~±5%	±0.25%~±5%	±0.25%~±5%
Relative Resistance Tolerance (%)	±0.25%~±0.5%	±0.1%~±0.5%	±0.1%~±0.5%	±0.25%~±0.5%	±0.1%~±0.5%	±0.1%~±0.5%
Insulation Voltage (V)	>1000VDC					
Resistive Ratio: R2/(R1+R2)	1:1000 to 1:20000					
Operating Temperature Range (°C)	-55°C ~ +125°C					
Coated	Silicone					
Terminal	Nickel plated copper cap					
Overload	5 times of Rated Power do not exceed 1.5UMax 5s, R <sub>≤</sub> ±(0.2%+0.05Ω)					
Load Life	1000Hrs. at Rated Power , ΔR <sub>≤</sub> ±(0.5%+0.05Ω)					
Steady heat	40°C , RH≥95%, 240Hrs , ΔR <sub>≤</sub> ±(0.4%+0.05Ω)					
Rapid Change of Temperature	-55~155°C at 5 cycles , ΔR <sub>≤</sub> ±(0.2%+0.05Ω)					

- Working Voltage =  $\sqrt{P * R}$  or Max. Working Voltage listed in above table whichever is lower.
- Overloading Voltage =  $\sqrt{5P * R}$  or 1.5 \* Max. Working Voltage listed in above table whichever is lower.

## Derating Curve (HI80M)

### Derating Curve

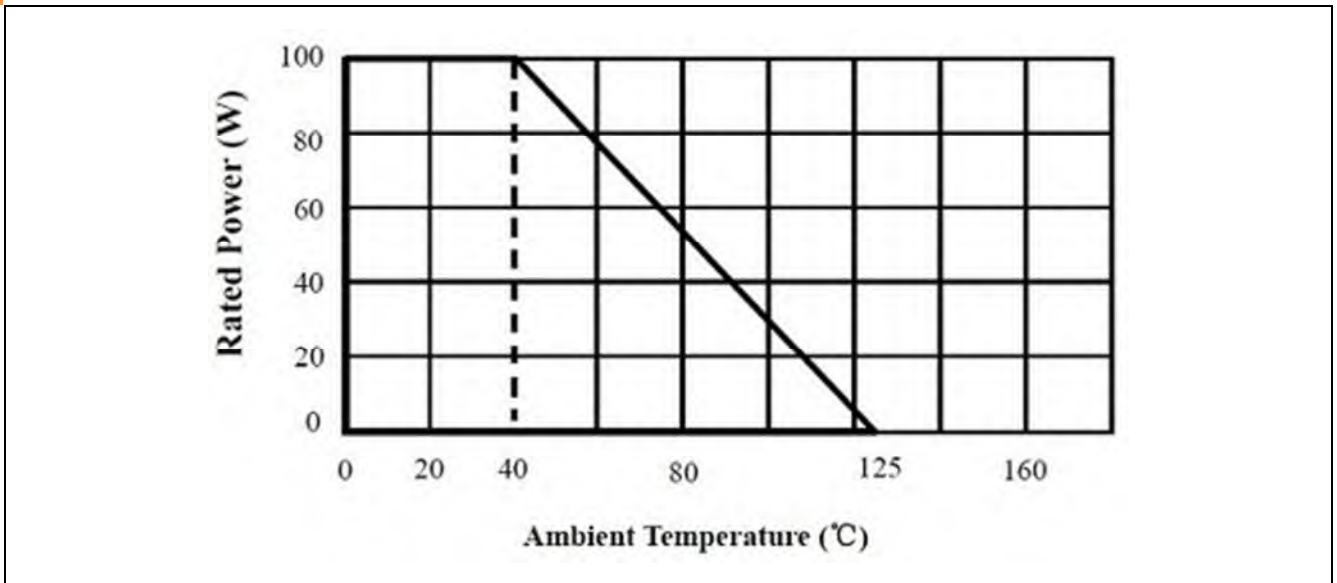

## Order Codes

### High Voltage Precision Divider Resistors - Order Codes (HI80M)

HI80M	156	C2C3	20M	5K	JD		
Part Number	Rated Power (W)		R1 + R2 (Ω)		Resistance Tolerance (%)		
HI80M	156	12W	20M	19.5MΩ + 5KΩ	5K	5KΩ	
	310	41W	30M	29.5MΩ + 5KΩ	1M	1MΩ	
			150M	148.5MΩ + 1.5MΩ	1M5	1.5MΩ	
		TCR (ppm/°C)					
		C1C2				JF	±5% absolute and ±1% relative
		C1C3				JD	±5% absolute and ±0.5% relative
		C2C3				FC	±1% absolute and ±0.25% relative

## ► General Information

### Cost Effective Complete Selection of High Voltage Components

Token high voltage series can be specified for use in industrial and general purpose high voltage systems, as well as a complete selection of high resistance, Hi-Meg, high-voltage, high frequency, and bulk ceramic resistors for higher average power dissipation. These High Resistance, High Frequency, High Resistance resistors combine the proven performance of Token resistance system with new cost efficient design elements and high voltage applications.

Detailed specifications, both mechanical and electrical, please contact our sales representative for more information.

### High Voltage Applications

Resistors produced from Serpentine Pattern Screen Printing Design or bulk ceramic materials have displayed several key advantages in demanding high-voltage situations, including both continuous-wave and pulse applications. These include radar and broadcast transmitters, x-ray systems, defibrillators, lasers, and high-voltage semiconductor process equipment applications, where resistors must handle peak voltage anywhere from 8KV to 75KV.

Typical applications include current limit in capacitor charge/discharge, crowbar, and tube-arc circuits. In these uses, bulk ceramic resistors provide low inductance, high average power per unit size, stability at high voltage, and durability at extreme peak-power levels. Film resistors typically cannot withstand high-voltage pulse applications.

### RF/Digital Loads and High-Frequency Applications

Token Non-Inductive Voltage Resistors are used extensively for high-frequency RF loads in broadcast and communication equipment because of their non-inductive characteristics. They provide excellent non-inductive power-handling capacity at frequencies up to the gigahertz range, with no sacrifice in power dissipation.

Film resistors may provide the needed non-inductive characteristics required by such RF applications, but they have size limitations and present reliability problems due to potential film burnout. This is especially true in advanced digital applications such as digital radio and TV transmitters involving pulses at high frequencies.

### Application Notes

- Due to the high voltage which can appear between the end cap and any adjacent metal part, resistors should be mounted at an adequate distance from other conductors.
- An appropriate number of resistors may be screwed together as a stick to provide an assembly which will be capable to withstanding any desired voltage, providing no individual resistor is subject to a greater stress or power dissipation than is recommended in its data sheet, and that appropriate anticorona devices are fitted.
- The axial termination should not be bent closer than twice the diameter of the terminal wire from the body of the resistor.

When resistors are required to be potted, the preferred encapsulant is a silicone compound.

### Oil Immersion

For some high voltage applications it is required to immerse the components in oil or gas to reduce the effects of corona and surface tracking. A special lacquer protected version of the resistor is available, suitable for immersion in transformer oil or SF6.